



Ultra Low Chest Freezer Lab Care Plus (-86°C)

User Manual and Warranty



CONTENTS

1	INTRODUCTION	3
1.1	Intended Use	3
2	SAFETY INSTRUCTIONS.....	4
2.1	Symbols	5
2.2	Temperature Monitoring.....	5
2.3	Initial Charge.....	5
3	LABELLING	6
3.1	Technical label	6
4	RECEIPT AND INSPECTION.....	6
5	INSTALLATION	7
5.1	Location	7
5.2	Environmental conditions of operation.....	7
5.3	Environmental conditions for transportation and storage.....	8
5.4	Unpacking	8
5.5	Electrical Connection	8
5.6	Battery	9
5.7	Levelling.....	10
5.8	Rubber Gasket	10
5.9	Body Construction (Special Insulation).....	11
5.10	Pressure Compensation Valve	11
5.11	Remote Alarm Installation	12
5.12	Final Check-up	12
5.13	Cleaning and Disinfection	12
6	DIGITAL CONTROL PLUS	13
6.1	Preliminary signs.....	13
6.2	Commissioning the Device.....	13
6.3	Turning the device ON/OFF	14
6.4	The display screen	15
6.5	Set Point setting.....	16
6.6	Battery Status	16
6.7	Temperature chart.....	16
6.8	Switching interior light on/off	17
6.9	Mute alarm	17
6.10	Historical Data Download	18
7	SETTINGS.....	19
7.1	Main MENU	19
7.1.1	Set Point setting.....	19
7.1.2	Battery status.....	19
7.1.3	Alarm/Data History Menu	20
7.2	Alarms setting.....	23
7.3	'User Identification' Function	23
7.4	Language.....	24
8	SERVICE MENU.....	25
8.1	Date / Time setting	25
8.2	Probe Data Readings.....	25
8.3	Alarms list	25
8.4	Unit name	25
8.5	Welcome page	26
8.6	Advanced functions	26
8.6.1	Product / Chamber Probe Calibration	26
8.6.2	Output test	27
8.7	Parameters	27
9	TEMPERATURE MONITORING.....	28
9.1	Set Point Control.....	28

10	ALARMS.....	28
10.1	Alarms.....	28
11	MAINTENANCE, CLEANING, AND CARE.....	33
11.1	Cleaning Procedure.....	33
11.2	Battery replacement.....	35
11.3	Spare Parts and Technical Support.....	36
12	TROUBLESHOOTING.....	37
13	USEFUL LIFE OF THE EQUIPMENT.....	39
13.1	End of useful life.....	39
14	TEMPERATURE CHART RECORDER (OPTIONAL).....	40
15	CO2 BACKUP SYSTEM (OPTIONAL).....	41
16	WARANTY.....	43
16.1	Waranty Certificate.....	44

1 INTRODUCTION

Ultra low Temperature equipment is designed to maintain a temperature between -40°C (-40°F) to -86°C (-122,8°F) with safety in an environmental environment between 15°C (59°F) and 30°C (86°F), only when the equipment is used for storage.

Ultra Low Temperature equipment are classified as CLASS I (Protection against electric shock) and have a CONTINUOUS OPERATION mode according to the standard UNE_EN_60601.

This product has been manufactured under strict quality controls and meets all the requirements established by Infrico. Each unit has been tested and its quality is ensured before being shipped. This equipment has been manufactured with recyclable materials, by means of an environmentally friendly production process.

Model	Voltage/ Frequency	Intensity (A)	Capacity (l)	Type	Door	Shelves	Dimensions L x W x H	
							Interior	Interior
CLF50086	230/50	5,8	500	Horizontal	Solid	-	1190x640x756	2011x954x1092
	230/60	5,8						
	115/60	11,31						
CLF70086	230/50	7,5	700	Horizontal	Solid	-	1470x640x756	2291x954x1092
	230/60	7,5						
	115/60	14,63						

Temperature range of the equipment: -40°C to -86°C (-40°F to -122.8°F)

Accuracy: ± 0,1°C (± 0,2°F)

Display error values: ± 0,2°C (± 0,4°F)

Please read this manual carefully before installing your new device to become familiar with all of its advantages.



OBLIGATION! This device must be used only for the purpose described in this manual.

1.1 Intended Use

The ultra low freezers described in this manual are high performance units for professional use. These products are intended for use as cold storage in research and as a general laboratory freezer, storing samples or inventories at operating temperatures between -40°C (-40°F) y -80°C (-122.8°F)

It is not considered a medical device and, therefore, has not been registered with a regulatory body of medical devices, that is, it has not been evaluated for the storage of samples for diagnostic use or for the samples to be reintroduced into the medical device body. This unit is not designed for use in unclassified hazardous locations or for the storage of flammable elements.



WARNINGS: This unit is not a fast freezing device. Freezing large amounts of liquid or high water content elements will temporarily increase the temperature of the chamber and cause the compressors to run for a prolonged period of time.

Avoid opening the door for extended periods of time as the temperature of the air chamber will increase rapidly. Also, keep the interior doors closed as much as possible. When ambient air, which is more humid, replaces the air in the chamber, the creation of ice can develop in the chamber more quickly.

2 SAFETY INSTRUCTIONS

In this manual and on the labels of this product, the terms Warning and Caution convey the following meaning:

- Warning: A potentially hazardous situation which, if not avoided, could result in serious injury or death.
- Caution: A potentially hazardous situation which, if not avoided, may result in minor or moderate injury or damage to equipment.

Please read this manual and the product labels carefully before installing or using this product. Failure to follow these instructions may cause the product to malfunction, which may result in injury or damage.

The use of electrical devices implies the implementation of basic safety instructions such as:

- Follow the recommendations in this manual to properly locate and place this device prior to installation.
- Do not allow children to handle the device, as they could damage it, or themselves, seriously.
- Do not touch the cold surfaces of the freezing devices, as such surfaces may adhere to skin.
- Do not store or use flammable products near the device.
- Unplug the device before any cleaning, repair or maintenance operation.



WARNING!: Any manipulation of the device must be carried out by an authorised technical support service provider.



WARNING!: 'No modification is permitted on this equipment.'



WARNING! We inform you that the person installing the device is responsible for carrying out the installation as instructed in the user manual.



WARNING! We remind you that you are responsible for the proper maintenance of the equipment. The manufacturer is not to be held liable for issues resulting from improper maintenance.

2.1 Symbols



WARNINGS



OBLIGATION



PROHIBITION



BATTERY



GROUNDING



NEED TO USE GLOVES



LOW EXTREME TEMPERATURE

2.2 Temperature Monitoring



Important note: We recommend the use of a redundant and independent temperature monitoring system, so that the ultra low freezer can be continuously monitored for a performance commensurate with the value of the stored product.

2.3 Initial Charge



Allow the freezer to operate at the desired temperature for a minimum of 12 hours before loading.



Caution Failure to follow these procedures or overloading the unit can cause excessive stress on the compressors or jeopardize the safety of the product.

3 LABELLING

In our equipment, labels are attached to the inside of the products. Their exact location is the top inner left side.

3.1 Technical label



CTRA. DE AGUILAR A A -318 POR
MORILES KM 15,5 – A-3



3000385652

CLF70086



MADE IN SPAIN

MFG. DATE 20/11/2020
FECHA FAB.

ALIMENTACIÓN POWER SUPPLY	220 V	1	50 Hz	INTENSIDAD TOTAL AMPS	8,9 A
POTENCIA POWER		1907 W		REFRIGERANTE REFRIGERANT	R600a/R1150
RES. ANTIVAHÓ ANTI-SWEAT HEATER		W		CARGA REFRIG. REFRIG. MASS	175/85 g
BANDEJA EVAPOR EVAPORATION TRAY				ESPUMANTE BLOWING AGENT	HFO
OTRAS RESIST. OTHER HEATERS		50 W		PODER CONGELACIÓN	KG/24H
ILUMINACIÓN LIGHTING		W		VOLUMEN ÚTIL NET CAPACITY	700 L
CONSUMO ENERG ENERGY CONSUM		KWH/24H		CLASE CLIMATICA CLIMATIC CLASS	4(30°C,55HR)

4 RECEIPT AND INSPECTION

- All Infrico products are factory tested to assess their quality and performance and are shipped free of defects.
- When you receive your device, it should be carefully examined for any damage that may have incurred during transportation.

- If any damage is detected on the unit, you must retain all packaging material and report such damage on the carrier's bill of lading. A claim must be immediately made to the transport company.
- If the damage is found during or immediately after installation, contact your distributor immediately.



WARNING: Infrico shall not be held liable for damages incurred during transportation.

5 INSTALLATION

5.1 Location

This device is intended for indoor use only.

Ensure that the location chosen for your equipment has adequate air circulation to ensure efficient refrigeration.

Avoid locations near heat sources, such as sunny windows, ovens, heaters, as well as direct solar radiation where temperatures can reach extreme values. In addition, do not choose a location in areas where temperatures drop below 12°C or rise above 32°C.

Install the ultra low freezer in a level area free of vibrations with a minimum of (20 cm) of space on the sides and (15 cm) on the back. The doors must be able to open a minimum of 90° in order to use the maximum available door width.

The surface of the final location where the device is to be placed must be strong enough to support the total weight of the device considering its full maximum load capacity. In addition, it must be levelled and free of vibrations. Reinforce the flooring if necessary.



WARNING: Make sure the device is placed in such a way it is easy to operate on the disconnection device (peg of the power cable).

5.2 Environmental conditions of operation.

Ultra-Low Temperature equipment are designed to be safe under the following conditions.

- Indoor use
- Altitude up to 2000 m (795 mbar)

- Temperatures from 12°C to 32 °C
- Maximum Relative Humidity: 60 %
- Voltage fluctuations in mains of up to ± 10 % of the nominal voltage.

5.3 Environmental conditions for transportation and storage

Ultra-Low Temperature equipment are designed to be safe under the following transportation conditions.

- Storage temperature: from -15 °C (5°F) to 55 °C (131°F)
- Relative humidity: 20 - 85 % (non-condensing)

5.4 Unpacking

The devices are shipped from the factory on a wooden pallet and are packed in sturdy wooden/carton boxes. The box is screwed to the wooden base. The screws must be removed prior to unpacking to avoid damage to the unit.

All packaging materials are environmentally friendly and should be reused or recycled. Actively contribute to the protection of the environment by demanding recyclable packaging and environmentally friendly disposal methods.

To make easier the unpacking, a ramp is included within the wooden base.



WARNING: Infrico does not recommend knocking the unit forward, sideways, or backward. However, if this occurs, you must ensure that the unit remains in an upright position for at least 24 hours before connecting it, so that the compressor oil returns to the compressor.

5.5 Electrical Connection



WARNING!: Connect the equipment to a dedicated outlet with the correct voltage for the device. Incorrect power or voltage fluctuations can cause serious damage to the equipment.



The equipment is prepared for a feeding of the mains 220-230V 50 Hertz, 220-230V 50 Hertz, 115V, 60Hz. The equipment counts on installed hose and pin in factory. Review the adhesive located in the

feeder. If it does not count on the taking of suitable current, must install it previously. The average one to isolate the equipment of the feeding network is the pin of the feeder.

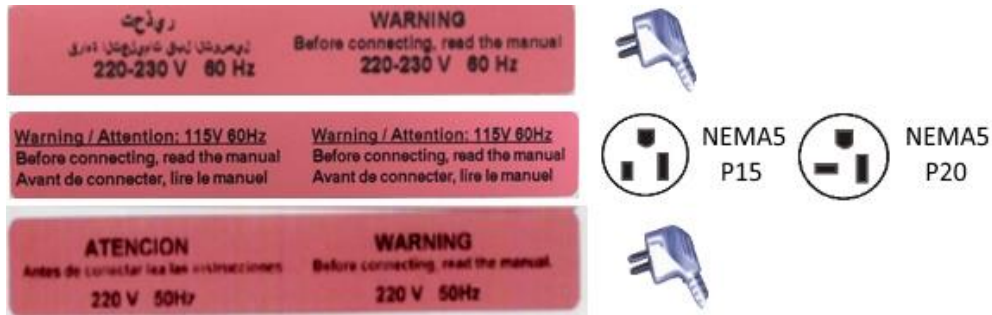

WARNING! This unit must be grounded before use in order to ensure personal safety and the proper operating of the equipment. A grounding fault may cause damage to personnel or equipment. Always comply with the National Electrical Code. Do not connect the equipment to power lines that are already overloaded.



OBLIGATION: The device must be connected to an exclusive dedicated circuit. Failure to comply with this requirement shall void the warranty.



WARNING! The device is designed to tackle a voltage fluctuation of around 10 % in relation to the rated voltage indicated in the rating plate. A compressor fault due to higher fluctuations shall automatically void the warranty.

Note: It is recommended to install a UPS (Uninterruptible Power Supply) or other system to avoid voltage peaks or lack of electric current supply.



WARNING! If the hose or the peg are altered in any way, they may constitute a serious hazard. Any alteration of these components shall void the warranty.



WARNING: Devices connected to an extension cord are not covered by Infrico's warranty.



WARNING: The power cable can only be replaced by an authorized technical support service provider.

5.6 Battery

The equipment is equipped with a 12V-12Ah rechargeable lead-acid battery. Once the equipment has been installed, it must be connected by an approved installer.



WARNING! For battery replacement information, see section 11.2.

5.7 Levelling

It is very important that the apparatus perfectly is made level for a correct operation, so that the water-drainages drain correctly, the doors are aligned, and the unit is not put under illegal tensions.

In this case, it must make sure that the ground where the unit is located is at level. In order to be able to work of stable form, to adjust to the legs leg to make sure that the equipment stable and is made level.

5.8 Rubber Gasket

To verify that the door is sealed, follow the steps below:

1. Opening the door.
2. Insert a strip of paper between the rubber gasket and the rubber gasket profile, and close the door.
3. Slowly remove the paper strip from the outside. While doing so, you should feel a little resistance.
4. Repeat this operation at 10 cm intervals covering the entire door frame. If the door does not close properly, the gasket needs to be replaced or the door needs to be adjusted.



CAUTION! Hermetic door sealing is essential for ultra low freezer to function properly. Faulty sealing allows humid air inside the device, which results in the accumulation of moisture in the evaporator, resulting in poor temperature maintenance, increased operating time, and increased operating costs.

5.9 Body Construction (Special Insulation)

All the equipment of ultra low temperature has 120mm of insulation core encapsulated by a sealed film laminate. In the case of CLF, only 120mm of insulation.



Be careful, never drill holes in or near the walls of the body. The perforation could damage the vacuum and make the unit inoperable.

5.10 Pressure Compensation Valve

When an outer door of the ultra low freezer is opened at low temperature, the air at room temperature quickly enters the interior. When the door closes again, the volume of air at room temperature cools down quickly, dropping the pressure below atmospheric pressure, resulting in a considerable vacuum. The opening of the outer door is impossible until the internal pressures return to atmospheric pressure. Without a pressure equalizing mechanism, it can take, in extreme cases, several hours before the door can easily reopen.

All ultra low temperature equipment has a valve that provides vacuum relief after the door openings. See the picture below to check the location of the pressure compensation valve.



5.11 Remote Alarm Installation

All ultra freezer models have a remote alarm connection that is located in the back of the equipment.



5.12 Final Check-up

Before commissioning the device, follow the steps below:

1. Make sure the unit is free of all wood or cardboard packaging materials, both on the inside and outside.
2. Verify that the unit is connected to a dedicated outlet.

5.13 Cleaning and Disinfection

Before commissioning the device, clean and disinfect it to remove any metal, plastic, sticker or residue left. Use water with a neutral detergent and dry properly.



CAUTION! Do not use a brush, acid, diluent, laundry soap, washing powder or boiling water to clean the device.

These may damage the painted surface, as well as the stainless steel surface, or the plastic and rubber components. Also, do not clean plastic and rubber components with a volatile material.

6 DIGITAL CONTROL PLUS

6.1 Preliminary signs

By 'operation mode' we mean the following modes:

- 'ON' mode (the device is turned on and the regulators can be turned on)
- 'Stand-by' mode (the device is turned on and the regulators are turned off)
- 'OFF' mode (the device is not turned on)



"ON" Mode

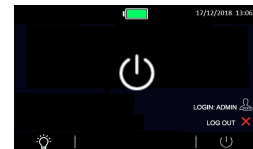

"Stand-By" Mode

'Turn on' means switching from 'stand-by' to 'ON' mode. 'Turn off' means switching from 'ON' mode to 'stand-by' mode.

Each time the device is connected to the power supply, it will return to the mode it was in at the time of disconnection.

6.2 Commissioning the Device

Operate as follows:

- 1.- Connect the device to the power source: A 'loading' message will be displayed on screen for a few seconds.

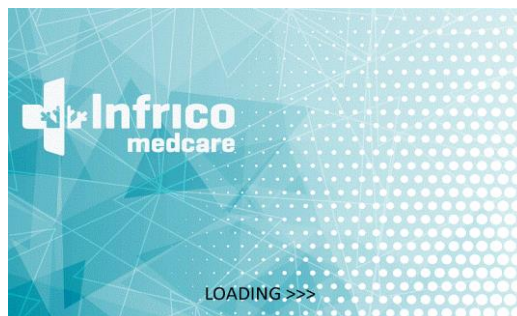

- 2.- Switch on the main red switch that turn on/off the supply and battery. It is located in the lower grid.
- 3.- The device will be on 'stand-by' mode, and the date and time will be displayed on the screen. If the controller is stored for longer than the backup battery capacity, the date and time will require resetting.

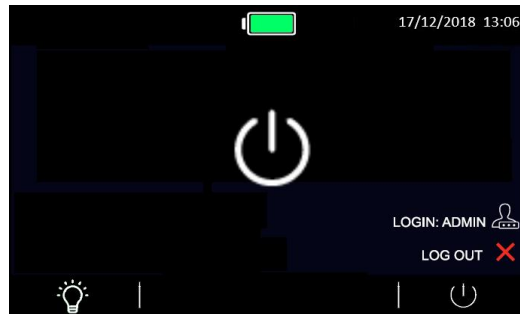

4.- Press the ON / STAND-BY icon . The home screen will be displayed as shown in the image. The default code is: **0000**.

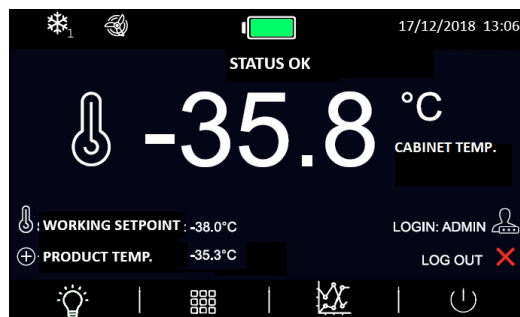

- If **“BLACKOUT”** warning is shown:

To make disappear the warning, press the text « Blackout » and go back to the main screen. It is shown to advise to the user that there was a power fault. It is completely normal after equipment delivery.

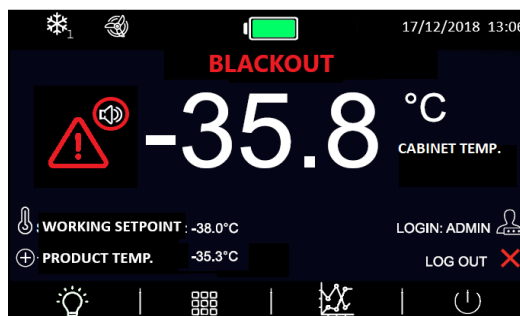

5.- Follow the device setting procedure explained in next chapters.

6.- Connect the loads to the power source.

6.3 Turning the device ON/OFF

To activate the ON/OFF device, operate as follows:

- 1.- Make sure that the keyboard is not locked and that there are no processes in progress.
- 2.- Press the ON/STAND-BY icon. The default code is: **0000**.

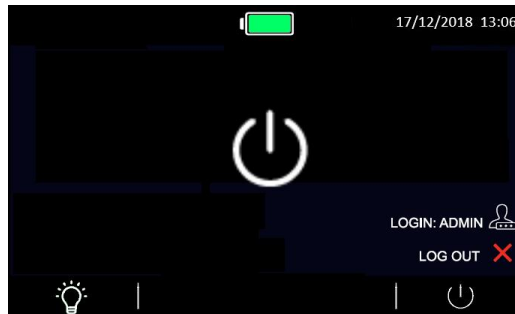

6.4 The display screen

When the device is turned on during normal operation, the following information will be displayed on the home screen:

- Time / Date
- Battery charge status
- Product / Cabin temperature
- Set Point
- Status icons

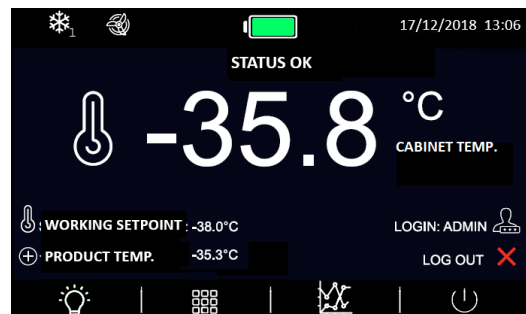

Compressor 1 ON icon



Compressor 2 ON icon



Evaporator Fan ON icon



Defrost ON icon

- Operation keys:



Lighting icon



MENU icon



Temperature chart



ON/STAND-BY icon

In case of disabled features, these icons will be displayed on the screen as shaded in grey.

6.5 Set Point setting

The temperature set point edit mode is enabled by pressing the  icon on the home screen.



6.6 Battery Status

To know the battery status is possible to access with the following icon  in the home screen or



through the main menu.

- In case of correct operation, the voltage provided by the battery will be displayed.
- In case of absence of the battery or any anomaly, the message "Battery problem" will be displayed.

If there are communication problems with the battery charger/back-up module, the message "Information not present" will be displayed.

The "Battery Status" option can be enabled according to parameters or if the user logged in at that time is enabled to display the battery status.

6.7 Temperature chart

Press the icon  to display the temperature chart with cabin and/or product temperature.

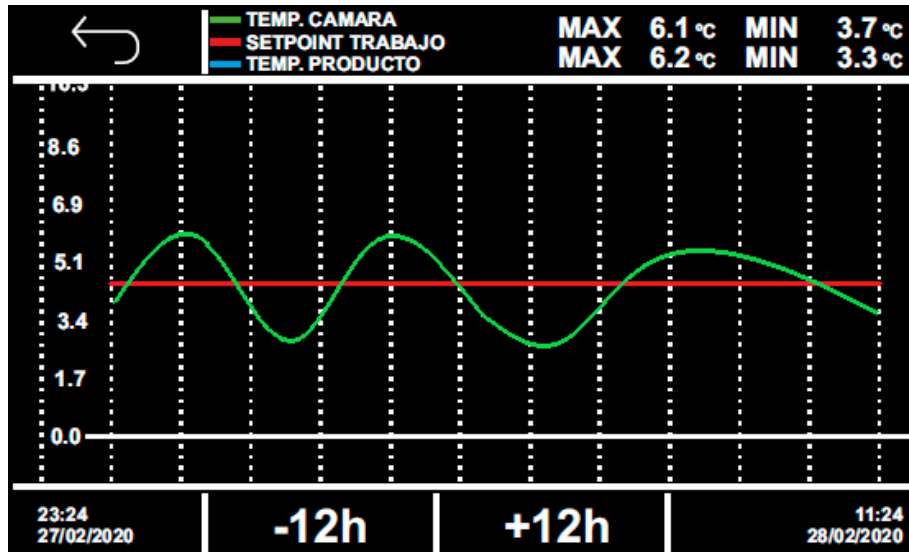

The screen shows in real time the last 12 hours.

The lines shown are the following:

- Product temperature in blue. (For ULF/ULT -86 will not be shown)
- Cabin temperature in green.
- Set point in red.

The coordinate axis (x) indicates the hours, while at the bottom left will indicate the time and date of the first record shown, while at the bottom right the time of the last data that appears in the graph. The ordinate axis (y) will show the minimum and maximum value of the temperatures.

Pressing the navigation icons, it will be possible:

-12h: It moves from the time -12 to the time -24 (with respect to the time 0 the request). And so on. If the data is not present, the message "NO DATA" will appear indicating the absence of data registered with that age.

+ 12h: Return with the graphics at time 0.

6.8 Switching interior light on/off

This function can be accessed manually, even if the keyboard is locked. The light switches on after pressing the 'light'  icon and after opening/closing the door.

6.9 Mute alarm

To disconnect the audible alarm, proceed as follows:

- 1.- Make sure that no process is in progress.

2.- Press  icon.

When pressing the key, the following icon  will be displayed.

6.10 Historical Data Download

To download the recorder data from the device, insert the USB key into the USB port on the keyboard while visualizing the main screen. Then, the message “Historical data download” will be displayed and confirming through “OK”, it will set the date / time for select the range of download (it will be between the date selected and the current date).

Then, the option “Download historical data” will appear and when confirming this option through “OK”. You must set the date / time from which, until the time of download we want to download the data. To set the date, press on each value that you want to modify and press again on the value to confirm the change. After setting the date, press “OK”.

The created file will have a .csv extension and can be opened by any spreadsheet application or Windows notebook. Wait for the message to remove the key to be displayed when the operation to remove the USB key has been completed.

Note: For the correct operation of the download, the USB key must be formatted in FAT32 and a USB 2.0 type. It is recommended that the size of the pendrive as much of 16 GB.



PROHIBITION! The USB connector shall be used only to connect a pen-drive for programming and data collection tasks.

7 SETTINGS

7.1 Main MENU

Press the icon  to Access the main MENU:

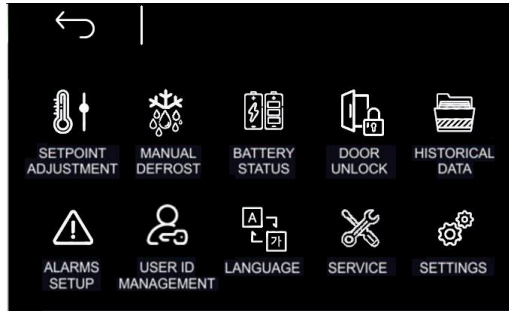

Once within the main menu, it is possible to access to different options, are as follows:

7.1.1 Set Point setting

Pressing  icon it is possible to change the working set point:



7.1.2 Battery status

Press the  icon to know the battery status.

- In case of correct operation, the voltage provided by the battery will be displayed.
- In case of absence of the battery or any anomaly, the message "Battery problem" will be displayed.

If there are communication problems with the battery charger/back-up module, the message "Information not present" will be displayed.

The "Battery Status" option can be enabled according to parameters or if the user logged in at that time is enabled to display the battery status.

7.1.3 Alarm/Data History Menu



Press the  to access the "Alarms/Data History" submenu, which includes the following functions/screens:



7.1.3.1 Historical alarms



Press the  icon to access the alarm display mode.

Up to 30 alarms with their related information can be recorded. The display shows the information related to the last alarm that occurred, upon accessing the menu, are as follows:

- Number of recorded alarms
- Type of alarm
- Date/time start-finish alarm
- The maximum/minimum product/cabin temperature reached in the chamber depends on type of alarm.
- In case of "Door open", "High chamber temperature" and "Low battery" alarms, the maximum temperature will be recorded.
- In case of "Low chamber temperature" alarm, the minimum temperature will be recorded.
- If the alarms are still active, the message "IN PROGRESS" will be displayed
- If no alarm is registered, the message "NO ALARMS" will be displayed

7.1.3.2 Door Opening Time



Press the icon to display the door opening record for the current day. Records from other days can be viewed by scrolling with the arrow icons. The date/time and duration will be displayed for each door opening record.

7.1.3.3 Operating Time Counter



Press the icon to display the equipment's operating time

The following data will be displayed:

- Refrigerator operating time.
- Compressor operating time.
- Average on/off compressor time.
- Compressor operating time percentage over day and time.

7.1.3.4 Historical delete



Press the icon to delete the historical data, and then, select the data you want to delete. The default password required to delete the historical data is 4598.

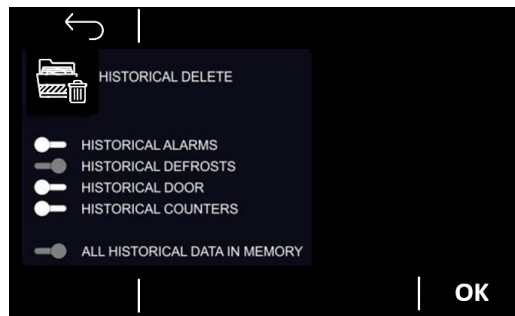

7.1.3.5 Historical setup



Press the icon to show the screen that allows for selecting the input, output and status records

The available data is organized in several pages: **(Click on the arrow in the up right corner to turn the page)**

- **Page 1:**

- ✓ Temperature observed from the probe that has been defined as a chamber
- ✓ Temperature observed from the probe that has been defined as product
- ✓ Temperature observed from the probe that has been defined as an evaporator
- ✓ Temperature observed from the probe that has been defined as a condenser
- ✓ Temperature observed from the probe that has been defined as reference
- ✓ Temperature observed from the probe used as a regulation probe
- ✓ Working set point

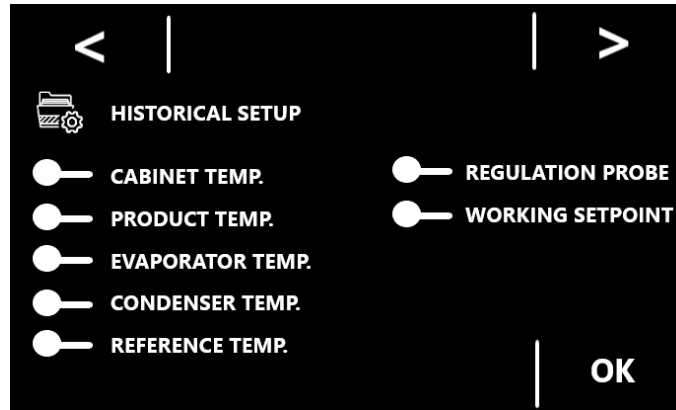

- **Page 2: BATTERY STATUS**

- ✓ Battery communication
- ✓ Battery alarm
- ✓ Emergency power supply
- ✓ Thermostat alarm
- ✓ CO2 Backup
- ✓ Antifreezing

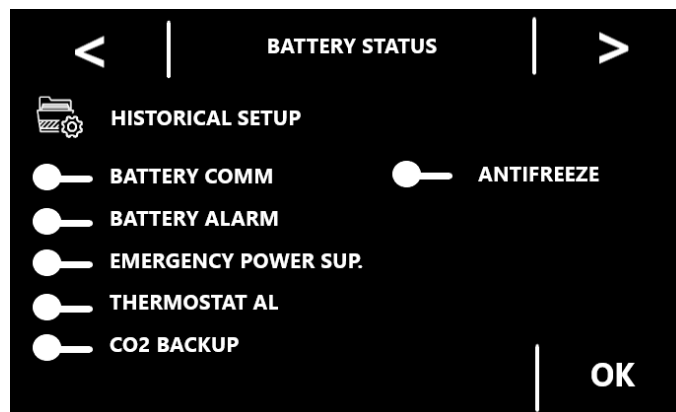

7.2 Alarms setting



To modify the limits for temperature alarms, press the  icon. It is possible to change the limits for High / Low product/cabin temperature warnings, also if the alarm is working related to the working set point in relative or absolute mode, as well as the delay of the alarm.

7.3 'User Identification' Function

Once the user is logged as ADMIN through the main screen, it will be enabled the USER ID Management function in the main Menu. Pressing this icon, it will be possible to

Once the user is logged as ADMIN through the main screen, the access icon to the USER ID Management menu will be enabled, which will allow to enable and manage up to 8 different login (User 1 to user 8) with fully constitutive access levels. The "user identification" function can be activated / deactivated in parameters.

Only the ADMIN user can access the ADMIN page and change the password of the other users. Passwords for the 8 users can be customized by pressing on the icon on the upper left.

To confirm the changes, press OK.

The default user code is: 0000.

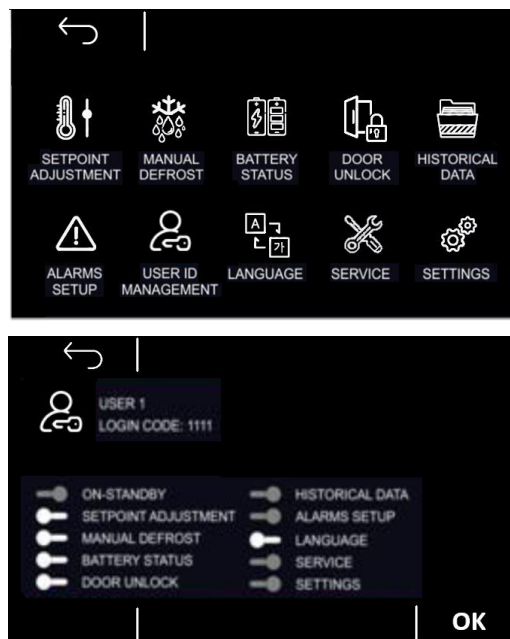

The controller requires the user identification code to perform any of the following actions:

- Turn the device on/off
- Edit the set point
- Manual defrosts
- Access to parameters
- Unlock the door after electronic locking

The actions performed will be recorded as special events in the historical data, along with the indication of the user who performed them. Each event will make a recording of the relevant temperatures and set point, which guarantees the continuity of the historical record results.

Find below an example of how to enter the user code when turning on the device:

- With the device in stand-by mode, press the ON/STAND BY icon.
- When the user login screen appears, enter the correct code and press “OK” to confirm and access the device.

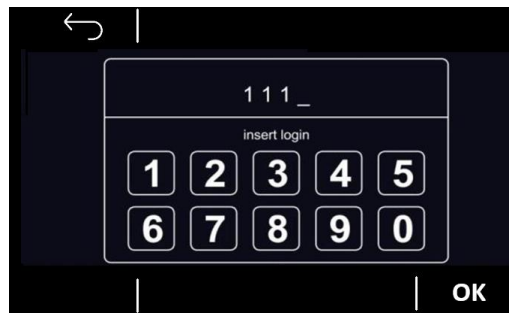

Similarly, the same user identification procedure will be required to turn off the device.

After logging in, any action performed within one minute of entering the login code will not require user information validation.

7.4 Language



Press the  icon to select the desired language. The available options are: ITALIAN, ENGLISH, SPANISH, FRENCH, AND GERMAN.

8 SERVICE MENU



Press the Service menu icon to access the "service" submenu, which offers the following functions/screens:

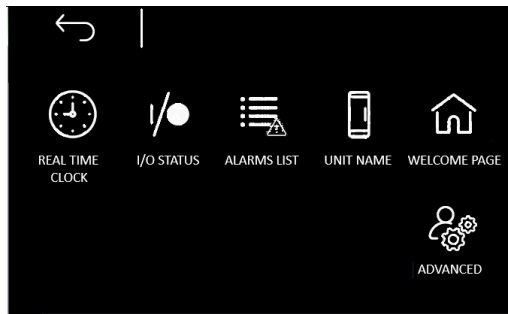

8.1 Date / Time setting



Press the icon to access the clock edit mode:

The arrow keys let you select the desired field on the clock, while the + and - icons let you modify the values. Press "OK" to confirm the new time and date.

8.2 Probe Data Readings



Press the icon to display the values detected by the probes.

8.3 Alarms list



Press the icon to display all enabled / disabled warnings on the device.

8.4 Unit name



Press the icon to assign a name to the unit and a serial number to the installed unit. The name is composed of a maximum of 10 characters and the serial number for a maximum of 10 digits. This name and serial number will be used as the header for the * .csv file that is obtained in the USB download.

8.5 Welcome page



Press the  icon to enable/disable the Welcome Page for each time the equipment is switched on. Therefore, several welcome pages appear that will allow the user / installer to quickly configure the equipment through a wizard, which will allow you to choose:

- Language
- Unit name
- Unit of measure in ° Celsius or ° Fahrenheit
- Minimum / maximum temperature alarms and pre-alarms for probes
- Enabling or disabling user access levels (if the profile of the user who made the access is ADMIN).
- Checkbox "Don't show it again" to disable the wizard after completing the machine start-up procedure.

8.6 Advanced functions



To access to advanced functions, press the  icon. After accessing, "Product/chamber probe calibration" and "Test in-line" may be selected.

8.6.1 Product / Chamber Probe Calibration

This function allows for calibrating the product/chamber probe according to the specific temperatures within a set range.

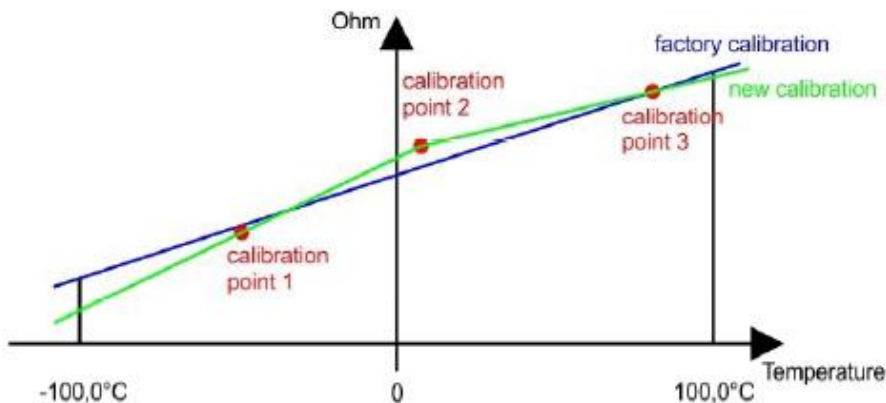

MAN-U-CLF86-EN Revision: 03 16/02/2023

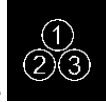

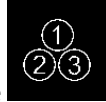
To start the procedure, press the  key and access a screen that enables calibration using 3 measuring points on both the chamber probe and the product probe.

8.6.2 Output test

Through this option it is possible to manually enable/disable one or more controller outputs independently of

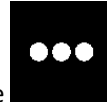

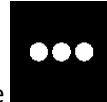
the current temperature regulation. It is accessed pressing the  icon.

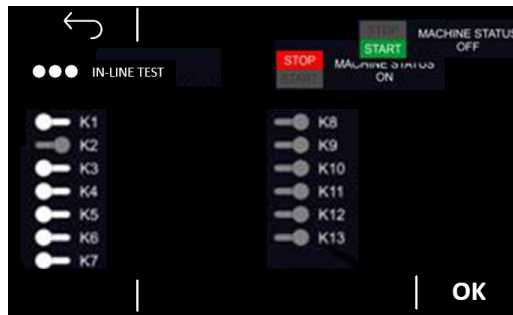

With the temperature regulation in progress, the upper right part of the screen allows you to lock or distribute the temperature control of the equipment to be able to take the manual control.

It is possible to individually turn on / off each output (relay). The relays are from K1 to K9 and K14.

After you have exited the screen, the regulation will resume automatically.

8.7 Parameters



Press the  icon on the "service" menu to access the device's internal parameters. If the parameter is enabled, a user code will be required.

Once pressing the icon, two options are available: "Parameters setting" y "Restore parameters". It will be needed to enter a password to access to each option.

9 TEMPERATURE MONITORING

9.1 Set Point Control

Your unit has been factory set and tested to maintain a chamber temperature of -82°C. For most applications, you will not need to change the temperature set point.

The chamber set point value is calculated according to the cut-off service parameters and a differential. To adjust the set point:

- 1.- Access the service parameters as shown in item 8.7.
- 2.- Adjust the cut-off values and differential as necessary.

10 ALARMS

10.1 Alarms



The alarm warning is displayed in red with the following icon

When an alarm occurs, the alarm type and corresponding icon are displayed in the description, while the alarm relay and buzzer are activated. To mute the buzzer, press the icon displayed.

When the condition that triggered the alarm is no longer active, normal operation of the device is resumed, unless otherwise stated in the following table.

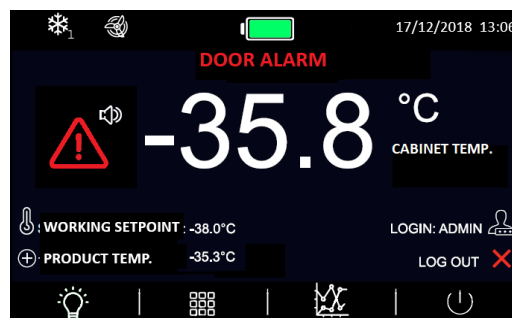

The following table describes the meaning of the device's alarm codes.

ALARM CODE	MEANING
Chamber probe err.	Probe error chamber alarm

ALARM	<p>Corrective measures:</p> <ul style="list-style-type: none"> - Check device - probe connection - Check chamber temperature <p>Main effects:</p> <ul style="list-style-type: none"> - The alarm is recorded - The buzzer and alarm relay will be triggered (if enabled) - Adjustment is carried out according to the ON/OFF and compressor working cycles.
High temperature ALARM	<p>Chamber high temperature alarm</p> <ul style="list-style-type: none"> - If chamber $T^{\circ} > \text{set point} + \text{Offset}$ - If the chamber $T^{\circ} > \text{set point}$, once delay periods have elapsed → alarm <p>Corrective measures:</p> <ul style="list-style-type: none"> - Same as above <p>Main effects:</p> <ul style="list-style-type: none"> - The alarm is recorded - The buzzer and alarm relay will be triggered (if enabled) - The alarm is automatically disabled when the dripping temperature is below the threshold.
Low temperature ALARM	<p>Low temperature alarm</p> <ul style="list-style-type: none"> - If chamber $T^{\circ} < \text{set point} + \text{Offset}$ - If chamber $T^{\circ} < \text{set point}$, once delay periods have elapsed → alarm <p>Corrective measures:</p> <ul style="list-style-type: none"> - Same as above <p>Main effects:</p> <ul style="list-style-type: none"> - The alarm is recorded - The buzzer and alarm relay will be triggered (if enabled) - The alarm is automatically disabled when the dripping temperature is below the threshold.
Power supply fault high temperature chamber ALARM	<p>High temperature alarm due to power supply fault</p> <ul style="list-style-type: none"> - If chamber $T^{\circ} > \text{set point}$ after shutdown due to power fault <p>Corrective measures:</p> <ul style="list-style-type: none"> - Same as above <p>Main effects:</p> <ul style="list-style-type: none"> - Energy cut-off and energy recovery time are recorded - The buzzer and alarm relay will be triggered (if enabled) - The alarm is disabled by pressing any key
Evaporator probe	Evaporator probe error alarm

<p>error ALARM</p>	<p>Corrective measures:</p> <ul style="list-style-type: none"> - Same as above, but in reference to the evaporator <p>Main effects:</p> <ul style="list-style-type: none"> - Defrost does not end and the evaporator fans cannot be activated - The alarm is recorded while defrost data is deleted - The buzzer and alarm relay will be triggered (if enabled) - Regulation is carried out as if the evap. probe were not installed: Defrost cycles end depending on time elapsed and fans are activated depending on chamber T°
<p>Evaporator low temperature ALARM</p>	<p>Evaporator low temperature alarm</p> <ul style="list-style-type: none"> - If evaporator T° < set point + Offset when door is closed <p>Corrective measures:</p> <ul style="list-style-type: none"> - Same as above <p>Main effects:</p> <ul style="list-style-type: none"> - The alarm is recorded - The buzzer and alarm relay will be triggered (if enabled) - Regulation is not affected and defrost is forced - The alarm is automatically disabled when temperature rises 2°C above the alarm setpoint
<p>Condenser probe error ALARM</p>	<p>Condenser probe fault alarm</p> <p>Corrective measures:</p> <ul style="list-style-type: none"> - Same as above, but in reference to the condenser <p>Main effects:</p> <ul style="list-style-type: none"> - The alarm is recorded - The buzzer and alarm relay will be triggered (if enabled) - Adjustment is carried out as if the condenser probe were not installed and condenser fans are activated in parallel with the compressor.
<p>Condenser high temperature ALARM</p>	<p>Condenser high temperature alarm</p> <p>If condenser T° > Admissible temperature</p> <p>Corrective measures:</p> <ul style="list-style-type: none"> - Same as above <p>Main effects:</p> <ul style="list-style-type: none"> - The alarm is recorded while defrost data is deleted - The buzzer and alarm relay will be triggered (if enabled) - Evaporator fans and compressor are switched off, while the condenser fans are switched on - If the alarm is activated while a defrost cycle is in progress, condenser fans are forced on regardless of the value of parameter

	<p>- The alarm is automatically switched off when temperature drops (According to parameters)</p>
<p>Condenser dirty. ALARM</p>	<p>Condenser dirty alarm</p> <p>- This alarm takes place when the difference between the condenser minimum temperature and the maximum value is (According to parameters) for two successive start-ups of the compressor</p> <p>Corrective measures:</p> <p>- Same as above</p> <p>Main effects: - Same as above</p>
<p>Compressor usage ALARM</p>	<p>Compressor usage alarm</p> <p>- If daily operation % > (According to parameters)</p> <p>Corrective measures:</p> <p>- Check efficiency status on the refrigeration system</p> <p>Main effects:</p> <p>- The alarm is recorded</p> <p>- The buzzer and alarm relay will be triggered (if enabled)</p> <p>- Adjustment is carried out according to the ON/OFF and compressor working cycles,</p>
<p>Product probe err. ALARM</p>	<p>Product probe fault alarm</p> <p>Corrective measures:</p> <p>- Same as chamber probe error alarm, but with reference to the product probe</p> <p>Main effects:</p> <p>- The alarm is recorded</p> <p>- The buzzer and alarm relay will be triggered (if enabled)</p>
<p>Product high temperature ALARM</p>	<p>Product high temperature alarm</p> <p>- If product $T^{\circ} > \text{set point} + \text{Offset}$ when delay periods have elapsed</p> <p>Corrective measures:</p> <p>- Same as above</p> <p>Main effects:</p> <p>- The alarm is recorded</p> <p>- The buzzer and alarm relay will be triggered (if enabled)</p> <p>- The alarm is automatically switched off when the temperature drops below the AUX4°C value below the threshold</p>
<p>Product low temperature ALARM</p>	<p>Product low temperature alarm</p> <p>- If product $T^{\circ} < \text{set point} + \text{Offset}$ when delay period has elapsed</p> <p>Corrective measures:</p> <p>- Same as above</p> <p>Main effects:</p>

	<ul style="list-style-type: none"> - The alarm is recorded - The buzzer and alarm relay will be triggered (if enabled) - The alarm is automatically switched off when the temperature drops below (According to parameters) below the threshold
<p>Defrost end time ALARM</p>	<p>Defrost end time alarm (only if parameter is enabled)</p> <ul style="list-style-type: none"> - If evaporator probe $T^{\circ} <$ (According to parameters) defrost ends T° when the maximum defrost time has elapsed <p>Corrective measures:</p> <ul style="list-style-type: none"> - Check the connection of the probe to the device - Check evaporator temperature <p>Main effects:</p> <ul style="list-style-type: none"> - Defrost ends - The alarm is recorded - The buzzer and alarm relay will be triggered (if enabled) - The alarm is disabled by pressing any key and it is restarted by pressing any key a second time
<p>Power fault ALARM</p>	<p>Power fault alarm</p> <p>Corrective measures:</p> <ul style="list-style-type: none"> - Verify the mains are operational - Check the connection of the device to the mains <p>Main effects:</p> <ul style="list-style-type: none"> - The digital input for turned on detection is activated, the outputs are deactivated, and all loads are switched off. - The buzzer and alarm relay will be triggered (if enabled) <p>as well, display backlight is activated according to the following sequence: 4 seconds on and 6 seconds off</p> <ul style="list-style-type: none"> - Values and alarms are recorded for the duration of the backup battery life

11 MAINTENANCE, CLEANING, AND CARE

11.1 Cleaning Procedure

Periodic cleaning of the device

To clean the device, follow the instructions below:

- Disconnect the equipment from the mains and remove all products stored in it.
- Open all doors and allow time for the interior to reach room temperature. Remove all interior accessories and clean them with soap and lukewarm water. Dry all accessories completely with a soft cloth.
- Once the chamber has reached room temperature, clean all interior and exterior surfaces with soapy water. Rinse thoroughly and dry with a soft cloth. Failure to dry the device properly may result in water stains. Stainless steel cleaners are also available in the market, which can repair and protect the protective layer of steel surfaces.
- Put the accessories back in place and connect the unit to the mains.
- Pitting corrosion or cracks in steel are signs of material deterioration. In this case, apply stainless steel cleaners capable of repairing the steel passivation.



WARNING: Never use steel scrubbers, wire brushed or spatulas to clean the device.



NOTE: Cleaning products used must be alkaline-based or chlorine-free. Any cleaner containing chlorides will damage the protective layer of the stainless steel.

Rubber gaskets maintenance



- Rubber gaskets require regular cleaning to protect their elasticity, to ensure proper sealing, and prevent mould growth. Rubber gaskets can be cleaned with soapy water. Avoid using abrasive cleaners or sharp utensils.
- Rubber gaskets can be easily removed in case replacement is needed by pressing them against the door frame.

Cleaning of the condenser



The condenser, located behind the grille of the device, should be checked regularly. Cleaning frequency will depend on the working environment. Air must flow freely through the condenser, so its surface must be free of dirt and grease. Dirty condensers cause compressor fault and product loss. If the condenser battery is dirty or blocked, follow the steps below:

- Disconnect the device from the mains.
- Remove the grille from the unit (There are 4 clips that fix the grille)

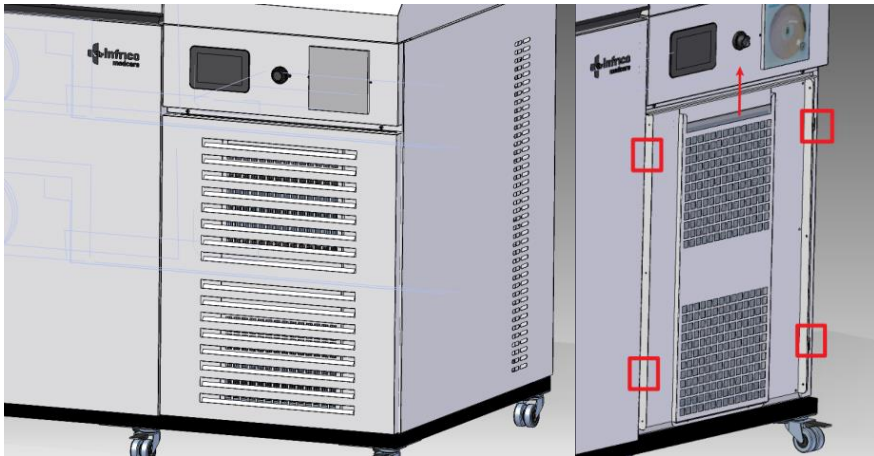

- If the condenser has a protective case, it must be unscrewed and removed.
- Once the surface of the condenser is accessible, it should be cleaned using a vacuum cleaner or a soft brush. Do not use metal brushes.
- If the dirt is excessive, compressed air can be used for cleaning.
- After cleaning, reinsert the protective case, return the condensing unit to its original position, and re-attach all screws.
- Finally, replace the rear grille and connect the device to the mains.



WARNING!: Do not use water to clean the condenser, as it may damage nearby electrical components.

Cleaning the condenser filter

Cleaning the condenser filter every two or three months.

- Open the front grille to access the filter. (There are 4 clips that fix the grille)

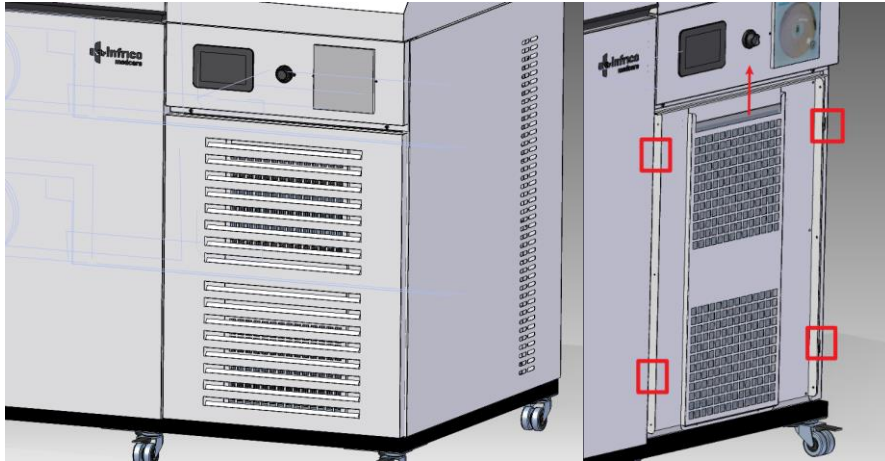

- Remove the filter
- Shake the filters to remove loose dust, rinse the filters in clean water, shake off excess water from the filters.
- Insert the filter in its position. Make sure the filter is completely dry before inserting it.
- Close the grid again.

Defrost the Unit

Defrost the unit once a year or whenever the accumulation of ice exceeds 10mm.

To defrost the unit, complete the following steps:

- 1) Empty all the products inside the equipment
- 2) Disconnect the equipment
- 3) Open the outer door and inner doors
- 4) Leave the freezer standing with the doors open for at least 24 hours. This allows both the internal cooling system and the foam system to be heated to room temperature.
- 5) Discard the ice and clean the water that is on the bottom of the cabinet.
- 6) If there is an ice smell, wash the interior with a solution of baking soda and warm water.
- 7) Clean the exterior with any common cleaner (See section 5.13)
- 8) Close the doors, restart the freezer and reload as indicated in section 2.3 Initial load.

11.2 Battery replacement



OBLIGATION!: Make sure the device is disconnected from the mains before carrying out any maintenance or repair work.

The equipment consists of a 12V-12Ah Lead-Acid rechargeable battery. Battery should be replaced only with another one of the same characteristics as mentioned above.

You should order Technical Service to replace the battery every 12 months.



PROHIBITION!: The battery may only be replaced by an authorised technical support service provider.

11.3 Spare Parts and Technical Support



OBLIGATION!: Make sure the device is disconnected from the mains before carrying out any maintenance or repair work.

If there is no recommended technical support service provider in your area, please contact us for a list of technical support service providers.

If the problem persists after the appropriate verifications, **DO NOT MAKE ANY REPAIRS YOURSELF.** Contact our Technical Support Service, and have the model and serial number of the device at hand (located on the technical data label),



WARNING!: If spare parts are needed, always insist on factory authorized spare parts.

Note: Wiring diagrams, exploded view diagrams, descriptions, calibration instructions and other information regarding the equipment are available upon request to assist the authorized technical support service provider in a repair.

12 TROUBLESHOOTING

Many operational issues derive from causes that can be easily eliminated without the need to contact the Technical Support Service. The following list covers several types of issues and how to solve them.

PROBLEM	POSSIBLE CAUSE	POSSIBLE SOLUTION
The apparatus does not work	<ol style="list-style-type: none"> 1. It is not plugged into the electrical socket. 2. No electrical current is reaching the plug because the fuse has blown or the automatic power limiter has been tripped. 	<ol style="list-style-type: none"> 1. Insert the plug into the electrical socket and check that there is electrical current. 2. Replace the fuse or reconnect the automatic power limiter.
The device is not cooling very much	<ol style="list-style-type: none"> 1. Check the cut-off temperature in the controller. 2. The door has not been closed properly or has been opened very frequently. 3. The device's ventilation grilles have been obstructed. 4. Condenser is dirty. 5. The device is directly exposed to sunlight or a heat source. 	<ol style="list-style-type: none"> 1. Reduce the cut-off temperature. 2. Ensure that the door is not kept open for long. 3. Keep these areas unobstructed as indicated in the "installation" section of this manual. 4. Clean with compressed air or a hard-bristle brush (not a steel one). 5. Move the refrigerator to a different location or shield it from the heat sources.
Noisy operation	<ol style="list-style-type: none"> 1. The device is not properly levelled. 2. Some of the internal tubes are touching. 3. Loose screws in a particular part. 4. Condenser or evaporator fan causes vibrations. 5. Too low oil charge in compressor. 6. Lose parts on condensing unit. 	<ol style="list-style-type: none"> 1. Level it as indicated in the "installation" of this manual. 2. Separate the tubes in contact. 3,6. Tighten the loose screws. 4. Level the equipment and tighten any loose screw. 5. If equipment was laid down on any of its faces, remain it 24 hours in an upright position without plugging it in, in order that oil returns to compressor. Also check for oil leaks.
The device creates too much ice in the evaporator	<ol style="list-style-type: none"> 1. Doors not properly closed. 2. Doors opened too often. 3. It has not been defrosted. 	<ol style="list-style-type: none"> 1,2. Ensure that the door is not kept open for long. 3. Defrost the device.

Compressor does not start working	<ol style="list-style-type: none"> 1. Disconnect switch open. 2. Blown fuse. 3. Defective wiring. 4. Overload protector tripped. 5. Open control contacts. 6. Defective relay. 7. Low gas charge in the system. 	<ol style="list-style-type: none"> 1. Close the disconnect switch. 2. Replace the blown fuse. 3. Check electrical wiring. 4. Check if there is an unusual low voltage in the power point. 5. Control may be defective, or unit location may be too cold. 6. Replace the relay. 7. Check for leaks.
Compressor does work, but stops on overload	<ol style="list-style-type: none"> 1. Low voltage. 2. Defective unit wire. 3. Starting capacitor defective. 4. Defective compressor. 	<ol style="list-style-type: none"> 1. Check if there is an abnormal low voltage at the power point. 2. Check electrical wiring and installation. 3. Replace starting capacitor. 4. Replace compressor.
High head pressure	<ol style="list-style-type: none"> 1. Overcharged with hot product unit. 2. Air or non-condensable gases in system. 3. Dirty condenser. 4. Defective condenser fan. 5. Unit location too hot. 6. Restriction in expansion valve, strainer. 7. Discharge valve partially closed. 8. Discharge line obstructed. 	<ol style="list-style-type: none"> 1. Check product temperature and keep it out of the equipment for its chilling, if it is very hot. 2. Vacuum seal the system. 3. Clean the condenser. 4. Replace the condenser fan. 5. Move the unit away from very hot locations. 6. Adjust expansion valve or strainer. 7. Adjust discharge valve. 8. Check and adjust discharge line.
Low head pressure	<ol style="list-style-type: none"> 1. Insufficient refrigerant charge. 2. Leak in the system. 3. Cold unit location. 	<ol style="list-style-type: none"> 1. Check for possible refrigerant gas leaks. 2. Repair system leaks. 3. Move the unit away from very cold locations.
Compressor short cycles	<ol style="list-style-type: none"> 1. Differential control set too close. 2. Refrigerant undercharge. 3. Refrigerant overcharge. 4. Discharge valve leaking. 5. Cutting out on high pressure control. 6. Dirty condenser. 	<ol style="list-style-type: none"> 1. Adjust the differential with the controller. 2. Check pressure control. 3. Adjust refrigerant level. 4. Replace discharge valve. 5. Adjust refrigerant charge to avoid overpressures. 6. Clean the condenser.

13 USEFUL LIFE OF THE EQUIPMENT

Our equipment has been designed for a useful life of approximately 20 years, considering the availability of spare parts and that, after reaching that point in time, we assume that the cost of repairing it may be higher than purchasing a new one.

13.1 End of useful life

The symbol and the recycling systems described below apply to countries within the European Union and do not apply to countries in other areas of the world.

Your Infrico product was designed and manufactured with high quality materials and components that can be recycled and/or reused.

The symbol means that electrical and electronic equipment, batteries and accumulators, at the end of their useful lives, must be disposed of separately from your domestic waste.

Note: If there is a chemical symbol printed below the symbol, this chemical symbol means that the battery or accumulator contains a certain concentration of a heavy metal. This is indicated as follows: Hg: mercury, Cd: cadmium, Pb: lead

Within the European Union there are separate collection systems for electrical and electronic equipment, batteries and used accumulators.

Please dispose of them properly at your local community waste collection/recycling centre.

Please help us protect the environment we live in!



WARNING!: Inform the waste manager that the equipment may contain biological remains.

14 TEMPERATURE CHART RECORDER (OPTIONAL)



The ultra freezers are designed to accommodate a circular chart recorder. The location of the recorder is in the lower grid of each equipment in a specific housing for this.

Set up:

- 1) Open the door with the key
- 2) Raise the boom to 90° (3)
- 3) Push the retaining clip (6) to raise the diagram
- 4) Remove the diagram (7)
- 5) Insert the battery (8) with the poles so correct, leaving The tape to facilitate its extraction.
- 6) Insert the diagram(7)
- 7) Lower the retaining clip (6) and push laterally
- 8) Lower the boom gently (3)
- 9) Manually rotate the diagram according to the day and time you want to record data(6)
- 10) Remove the protection sleeve from the pen
- 11) Close the door with key

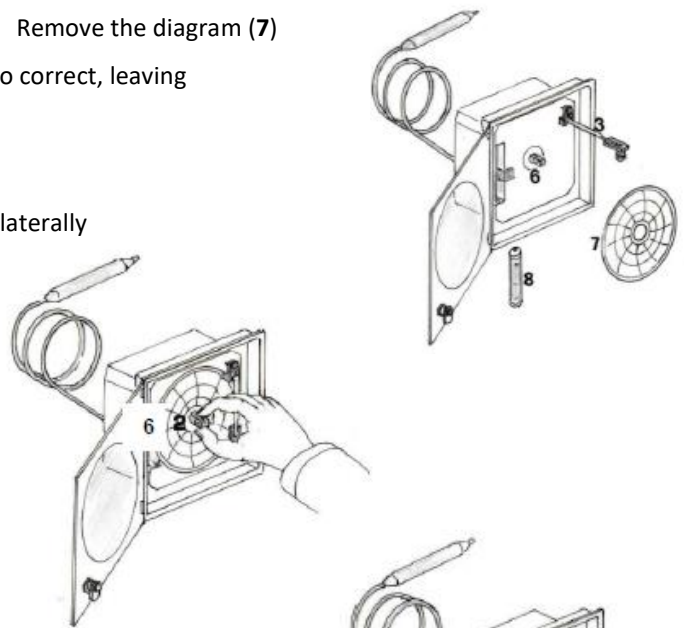

Replacing the diagram:

- 1) Push the retaining clip (6) to raise the diagram
- 2) Remove the diagram (7)
- 3) Insert the new diagram
- 4) Lower the retaining clip (6) and push laterally

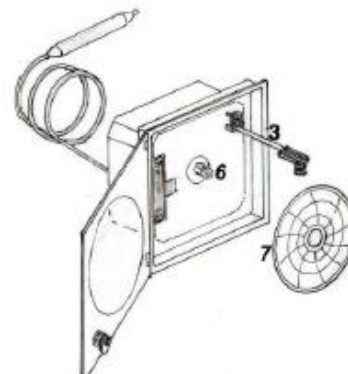

Replacing the pen:

- 1) Remove the pen carefully (4) so as not to damage the tip(3)
- 2) Place the new pen on the tip

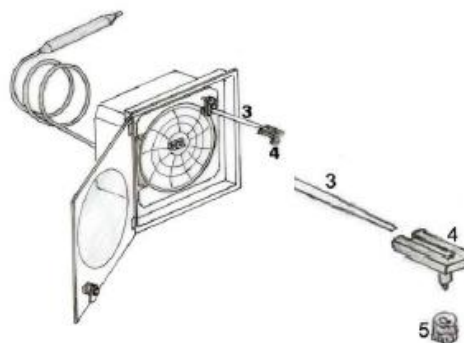

15 CO2 BACKUP SYSTEM (OPTIONAL)

The Ultra freezers are designed to optionally incorporate a CO2 backup system, which must be installed in the factory. To work properly, it is necessary to use liquid CO2, do not use gaseous CO2.

The CO2 backup system has been designed to provide a system of maintaining the contents of your Ultra freezer at a pre-set temperature in case of the power supply or cooling system fail. The CO2 backup system is supplied without CO2 bottles.

The CO2 backup system is plugged into a battery and has a factory **default temperature of -65°C**. When the temperature inside the Ultra freezer increases above the setpoint temperature, the injector is activated, releasing CO2 inside the cabinet.

If the door is opened during the CO2 injection, a door opening sensor disable the gas injection while the Ultra freezer remains opened. This prevents the user from being burned by the extremely cold gas stream.

1.1. Part list (PREINSTALLED AT FACTORY)

REFERENCE	DESCRIPTION	QTY
305X48	ELECTROVALVE SCB264D009 12V.DC	1
306X05	COPPER TUBE 1/4 x 0.030	2
306X23	NUT SAE 1/4"	3
405X14	MAGNET SENSOR E512 1V	1
10UL7070_01	OMEGA REAR BLACKUP CO2 ULF WHITE	1
S10UL7071_01	VALVE COVER BACKUP CO2 ULF WHITE	1
603X288	CABLE GLE CGA-1 BLACK	3
506X172	MAGNET DIAM.20mm CODE. GTN-20	1
705X148	MACHON 1/4 GIB to 1/8 GAS NICKEL PLATED	2
10UL400G99	ROUND FOR ELECTROVALVE CO2 BACKUP	1
308X158	POWER RELAY 12V DC - RS:6867054	1
406X66	ROCKER SWITCH 12V DC RS:0273003	1

1.2. First use PREINSTALLED.

- Make sure that all wires are connected.
- Make sure that the equipment is working, and the door is closed.
- The CO2 Backup kit have a 300 minute delay on the first start. It will not work until has passed 300 minutes.

If you need to modify the setpoint temperature of the backup system, follow the steps below:

it is necessary to change the **parameter U9**.

1.2.1. Press the icon  to access the main MENU:

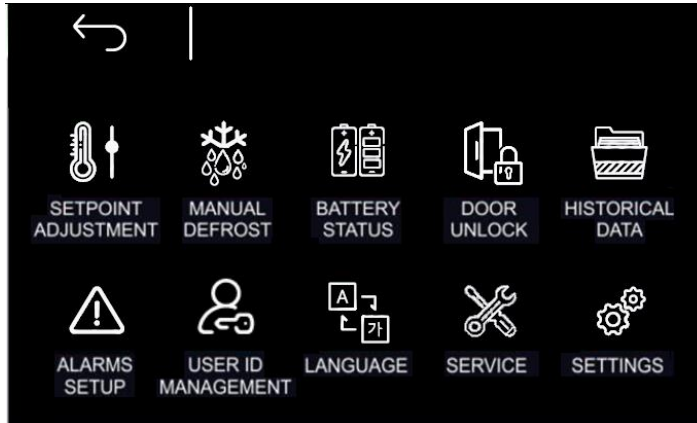

1.2.2. Press the  icon on the "service" menu to access the device's internal parameters. If the parameter is enabled, a user code will be required.

1.2.3. Once pressing the icon, two options are available: "Parameters setting" y "Restore parameters". It will be needed to enter a password to access to each option. Press the option "**Parameters setting**". The **password "-19"** will be required.

1.2.4. Look for the **parameter U9** and change the value to the temperature desired.

Note: The CO2 backup system works with time intervals which are defined according to **parameters E27 and E28**.

16 WARRANTY

Dear client, we would like to inform you that the products manufactured and sold by Infrico S.L. are equipment intended for industrial, non-residential use. Therefore, their warranty is not regulated by the consumer and user protection law but by the laws of commercial warranties.

- Infrico S.L.'s warranty covers any manufacturing defect or any hidden defect in the device during the period stipulated in the commercial contract. The warranty that Infrico as a manufacturer grants to its commercial network covers defective parts shipped freight paid, and it is the distributor's responsibility to cover the repair warranty (labour and consumables); and of course, the commissioning of the equipment in the first installation onsite, unless other conditions are agreed upon in the commercial contract.
- It is the responsibility of the distributors to attend to end user's warranties, ordering from Infrico S.L. all necessary components for repairs or replacements.
- The warranty does not cover breakage of glass after delivery by Infrico or parts damaged by improper use or normal wear.
- If, during the first 3 months of operation, an anomaly is detected in the device which, due to its magnitude, is disproportionate to the value of the equipment, a complete replacement of the equipment could be granted. After this period no substitution will be considered in any case.
- Any intervention on the device that affects the electrical connection, refrigerating parts or the electronic microcontroller not authorized by our technical support service shall void the warranty period remaining on the machine.
- If, exceptionally, the distributor is unable to carry out a repair, the technical support service may authorise the pickup of a machine to be repaired at Infrico S.L.'s premises to then be returned to the client. If the repair is not performed within the warranty period, the client shall be charged for the costs of such repair and transport.
- All returns authorized by the technical support service, either for repairs or replacements, are inspected at our facilities. If anomalies other than those claimed and unrelated to our manufacture or due to misuse or wear are detected, Infrico S.L. shall not be responsible for the costs of repairs or replacements that may be required, which shall be borne by the client.
- The conditions of the warranty shall not be modified unless a written agreement to modify the conditions of the supply contract has been previously entered into with the client.

José Luis Crespillo
Director de Calidad
Infrico S.L.



Infrico SL.

Ctra. De Aguilar a A-318 por Moriles km 15,5 - A-3132

14900 Lucena (Córdoba) España

00 34 957 59 51 14 office

00 34 957 59 11 83 fax

info@infricomedcare.com

www.infricomedcare.com

CE