



Air-Jacketed Automatic CO₂ Incubator

Models

**NU-5810, NU-5820, NU-5831, NU-5841
NU-5810E NU-5820E, NU-5831E, NU-5841E**

Operation and Maintenance Manual

February 2024

Revision 9



For 115 Vac, 50/60 Hz Only

Manufactured By:

NuAire, Inc.

2100 Fernbrook Lane

Plymouth, MN 55447

Toll-Free: 1-800-328-3352

In Minnesota: (763)-553-1270

Fax: (763)-553-0459

Air-Jacketed DHD Invitrocell CO₂ Incubator

Operation & Maintenance Manual
NU-5810, NU-5820, NU-5831, NU-5841
NU-5810E, NU-5820E, NU-5831E, NU-5841E

Table of Contents

Section No. 1.....	General Description
Section No. 2.....	Performance Parameters and Features
Section No. 3.....	Models & Features
Section No. 4.....	Test Performance & Procedures
Section No. 5.....	Warranty Disclaimer
Section No. 6.....	Shipments
Section No. 7.....	Installation
Section No. 8.....	DHD Operation
8.1	Sterility
8.2	Humidity
8.3	Control System Introduction
8.4	NuTouch Display Screen
8.5	Rear Component Panel Detail
8.6	Front Component Panel
8.7	Run Mode Operator Interactions
8.8	Standby Mode Operator Interactions
8.9	Diagnostic and Checkout Procedures
8.10	Option Configuration Parameters
8.11	Resetting the Electronic Software
Section No. 9.....	Calibration
9.1	Chamber Temperature Calibration
9.2	Door and Perimeter Heater Adjustments Affecting Temperature Calibration
9.3	Setting Air Injections
9.4	CO ₂ Calibration
9.5	RH Calibration
9.6	O ₂ Calibration
Section No. 10.....	Maintaining Your DHD Invitrocell
10.1	Heated Decon Cycles
10.2	Chemical Decontamination of the Incubator Chamber
10.3	Power Loss recovery mode
10.4	Shutting down the incubator
10.5	Automatic Filter Change Notification
Section No. 11.....	Error Indicators & Troubleshooting
Section No. 12.....	Communication Outputs
Section No. 13.....	Electrical/Environmental Requirements
Section No. 14.....	Disposal and Recycle

MANUAL DRAWINGS

BCD-18314	Dimensioned Assembly NU-5800/E
BCD-19904	DH/D Interior Prep
BCD-15170	Rear Component Panel Assembly

ASSEMBLY DRAWINGS

BCD-18316	Front Component Panel
BCD-15872	Electronics Panel Assembly
BCD-20375	Sensor Bay Assembly
BCD-18320	Tubing Diagram
BCD-18317	Incubator Right Hinge Door Assy
BCD 18321.....	Incubator Left Hinge Door Assy

ELECTRICAL SCHEMATICS

BCD-17790	Electrical Schematic, NU-5810/E
BCD-18007	Main Control Board Electrical Schematic

**DHD Direct Heat
Invitrocell CO₂ Incubator
Models: NU-5810, NU-5820, NU-5831, NU-5841
NU-5810E, NU-5820E, NU-5831E, NU-5841E**

Operation and Maintenance Manual

1.0 General Description

The NuAire Direct Heat Decon (DHD) Automatic CO₂ Direct Heat Incubator has been designed to provide a reliable controlled In-vitro environment for optimum tissue cell culture growth. The chamber also provides an environment for the storage and preservation of gametes and animal tissue cell cultures intended for research at or near body temperature.

There are five parameters that contribute to optimum growth conditions, they are:

- Humidity
- Precise temperature control
- Precise CO₂ control
- Sterility
- Reliability

Like all NuAire equipment, this Incubator has been designed to provide the highest quality standards of performance with matching computer technology, precise temperature control, and CO₂ gas control system combining state-of-the-art technology with years of design, quality, and manufacturing experience.

1.1 Incubator Chamber

The design and size of the DHD inner chamber provides a large capacity (5.7 cu. ft.), and ease of use. The chamber walls are directly heated by physically attached foil heating elements on the sides, bottom, top, and back of the chamber, providing a temperature uniformity of $\pm 0.3^{\circ}\text{C}$. A high-density insulation that has a high "R" rating covers the complete outer surfaces of the Incubator inner chamber.

1.2 Incubator Closed loop chamber sample circulation system & HEPA Filter

A continuous operating air pump draws an environmental sample from the chamber and circulates it through a HEPA filter capsule then through sensors that measure CO₂ volume (as a percentage) in the chamber for monitoring and control.

1.3 Incubator Control Electronics

The NuAire Incubator Control Electronics is a state-of-the-art microcomputer-based control system specifically designed to service the precise control requirements of the chambers environment, providing optimum programmable conditions for culture growth. The microcomputer is "user-friendly" and provides a 5x7 LCD screen which provides operating control parameters, status indicators, additional key operational parameters, and an imbedded touch panel to permit efficient operator entry of data.

The microcomputer is supported with Read Only Memory (ROM) containing executable software, Random Access Memory (RAM) for temporary storage, and Electronically Erasable Programmable Read Only Memory (EEPROM) for control set points and parameters. The EEPROM provides for indefinite storage of these values during periods of power off or power interruption (power fault tolerant).

1.4 Incubator CO₂ Control

The NuAire direct heat Incubator incorporates a microprocessor-based, non-dispersive infrared CO₂ induction sensor. The amount of energy received at the detector is an approximate logarithmic function of the CO₂ concentration in the gas between source and detector. The wavelengths used are absorbed only by CO₂ making the measurement insensitive to other components, such as water vapor. Detector linearization is performed with 32-bit digital accuracy. Advanced design provides a very stable output minimizing drift and requiring less frequent calibration. The output is digital, alleviating errors brought about by analog signals. Calibration of this control is accomplished by a zero & span calibration done on the sensor and a display off-set calibration. These calibrations are accessible through the *NuTouch LCD* located on the front of the unit.

1.5 Incubator Construction

The outer shell of the air-jacketed Incubator is cold-rolled steel with a powder coat paint finish. The front frame surface of the outer shell is heated with a foil type heater directly attached behind the front perimeter opening.

The front frame perimeter heater, as well as the outer front door heater is duty cycle controlled (manually adjusted for specific ambient conditions) to balance the heat that reaches the chamber and thus reduces the possibility of condensation forming on the inner glass door and the inner chamber walls.

The inner chamber is 16-gauge, type 304L, polished stainless steel using crevice-free construction, which provides an easily cleanable inert surface that does not in itself promote biological growth. In addition, all shelves, shelf supports, and guide rails are easily removable and can be autoclaved separately if so desired.

Remember: The chamber environment is not selective. The growth environment is applied equally to all microorganisms (specimens and contaminants) within the chamber.

1.6 Incubator Humidity

Models NU-5810 and NU-5831

A relative humidity level of up to 95% is achieved in the Incubator by the use of a stainless-steel pan filled with distilled water no purer than 1 megaohm and placed on the bottom of the chamber. It is necessary to set the duty cycle of the door and front perimeter heater in proper proportions to reduce the possibility of condensation forming on the glass inner door and the chamber walls. It is also important to thoroughly wipe the walls and the glass door clean before adding the humidity water pan. Condensation will occur more readily at contamination points. There is no electronic sensing and thus no automatic control of the humidity level in the air jacketed Incubator. An air pump injects fresh air into the chamber at a preset duty cycle to reduce condensation forming on the chamber walls and front glass door. The air injections are settable by the user to help control condensation. (See section 9.3 for this option.)

Models NU-5820 and NU-5841 use a humidity monitoring/control system for chamber humidity; the system is external to the chamber. The chamber air is routed through the water vapor saturated air in an evaporator box to add humidity when the RH sensor indicates that more humidity is required maintain a set point.

1.7 Cabinet Ventilator Fan

An axial fan is mounted to the bottom panel of the Incubator and runs continuously when the unit is switched on. The fan pulls air into the cabinet shell through the top panel louver openings and discharges it out of the bottom of the unit. The operation of this fan is necessary to assure accurate chamber temperature control over the 60°F to 85°F (15°C to 30°C) ambient temperature range that the equipment may see.











1.8 Safety Instructions

These safety instructions describe the safety features of the INVITROCELL Incubator.

The incubator has been manufactured using the latest technological developments and has been thoroughly tested before delivery. It may, however, present potential hazards if it is not used according to the intended purpose or outside of operating parameters. Therefore, the following procedures must always be observed:

- The incubator must be operated only by trained and authorized personnel.
- For any operation of this unit, the operator must prepare clear and concise written instructions for operating and cleaning, utilizing applicable safety data sheets, plant hygiene guidelines, and technical regulations, in particular.
 - Which decontamination measures are to be applied for the incubator and accessories?
 - Which protective measures apply while specific agents are used?
 - Which measures are to be taken in the case of an accident?
- Repairs to the device must be carried out only by trained and authorized expert personnel.
- Keep these operating instructions close to the unit so that safety instructions and important information are always accessible.
- Should you encounter problems that are not detailed adequately in the operating instructions, please contact your NuAire Representative or NuAire technical Services.

1.9 Explanation of symbols

Symbol (in text box)	Description (in text box)
	<p>Safety alert symbol indicates a potentially hazardous situation which, if not avoided, could result in death or serious injury.</p>
	<p>Safety alert symbol indicates a potentially hazardous situation which, if not avoided, may result in minor or moderate injury.</p>
<p>CAUTION</p>	<p>CAUTION used without the safety alert symbol indicates a potentially hazardous situation which, if not avoided, may result in property damage.</p>
	<p>Potential electrical hazard, only qualified person to access.</p>
	<p>Biohazard</p>
	<p>Ground, Earth</p>
	<p>Hazardous Gases! Personal Protection Equipment Required.</p>
	<p>Chemical Hazard</p>
	<p>Flammable Hazard</p>
	<p>Lead Free</p>
	<p>Hot Surface Burn Potential</p>

2.0 Performance Parameters and Features

- Both the interior and exterior of the DHD are constructed of 18 to 16-gauge steel. The interior is highly polished type 304 L 16-gauge stainless steel, using crevice-free construction. All exposed edges are deburred to ensure no sharp edges. The exterior is cold rolled 16- & 18-gauge steel finished in a powder-coated polyurethane finish, which is resistant to chemicals and easily cleaned using mild household detergents.
- The DHD's microcomputer temperature control system has two temperature sensors located inside the chamber at the back wall. The temperature sensors compare the values to a set point and execute a differential control algorithm that energizes a solid-state switch, supplying power to the heaters.
- Easily removable inner shelves and rails for sterilization.
- Up to 16 shelves can be placed inside the chamber (4 shelves are shipped with each DHD).
- Space-age high-temperature material is used to insulate the inner chamber walls.
- Foil heaters are directly attached to the chamber walls and the top and bottom surfaces of the inner chamber.
- Most electronics, motors, pumps, and valves are fully accessible from the back of the unit.
- Access to the filters and CO₂ sensor through the front of the incubator.
- A CO₂ sample port is provided on the front panel just below the door to check the concentration of CO₂ in the chamber.
- The CO₂ percentage is controlled by a solid-state gas infrared sensor using a single light source with dual wavelength detection, providing accurate monitoring of CO₂.
- Automatic recovery of the CO₂ level, after a 1-minute door opening, to 5.0 +.02/- 0.5% is in 5 minutes on average.
- The outer door includes an internal radiant heater in order to minimize condensation on the inner glass door. A magnetic outer door gasket helps to ensure a tight seal against the cabinet.
- The inner glass door is 3/16" tempered with smooth-ground edges and seals are tight against a silicone rubber gasket. The door latch is cam action. A momentary switch monitors the door position, the position being opened or closed.
- All control electronics are protected with a circuit breaker that may trip at 110% of loading rating but will trip at 145% of load rating in less than 2 seconds.
Should the circuit breaker open (pop-out button will appear), merely depress to reset.
- The Incubator has factory-installed adjustable leveling legs to compensate for uneven laboratory surfaces.

3.0 Models & Features

3.1 Invitrocell DHD (heated decontamination) all Models.

3.2 Dimensions (see also Specification Drawing BCD-18314)

Overall Dimensions - inches (mm):	Model NU-5810/E - NU-5841/E
Height:	Exterior: 39.688 in (1008 mm)
Width:	26.750 in (680 mm)
Depth:	27.188 in (691 mm)
Footprint:	23.5 in (597 mm) wide x 20.75 in (527 mm) deep
Height:	Interior: 28.500 in (723.900mm)
Width:	21.257 in (539.928mm)
Depth:	20.053 in (509.346mm)

Shelf Capacity:

Size:	19.75 Inches (502mm) x 18.75 Inches (476mm)
Supplied:	4 Shelves
Maximum Capacity:	20 Shelves
Maximum Weight Capacity	25 lbs. per DHD shelf 125 lbs. per DHD Incubator

(Make sure the self is empty before changing position or removing.)

Water Pan:

Dimensions:	Mean Length	12.0 inches (305mm)
	Mean Width	10.0 inches (254mm)
	Depth	1.5 inches (38mm)
Capacity:	Maximum	2.0 Liters
	Recommended Fill	1.5 Liters

3.3 Performance Parameters:**Temperature Control: Available on All Models Performance Determined with O₂ Set Point @ 21.0%**

- Temperature Range: 5°C to 55°C (37°C default) (5°C above ambient to 30°C maximum ambient)
- Temperature Uniformity: $\pm 0.3^{\circ}\text{C}$ @ 37°C.
- Temperature Accuracy: $\pm 0.1^{\circ}\text{C}$.
- Temperature Recovery: 0.12°C/minute Average
- Temperature Display Resolution: 0.1°C
- Temperature Sensor Type: Precision Integrated Circuit
- Minimum Qualifications for Decontamination/Sterilization:

	145 DEG Cycle:	95 DEG Cycle
Temperature:	145°C	87°C
Time:	3 Hr.	9 Hr.
- Door and Perimeter: Proportional base duty cycle based on Temperature set point and -20 to +20% manually adjustable to adapt to ambient conditions.

CO₂ Control: Available on All Models Performance Determined with O₂ Set Point @ 21.0%

- CO₂ Range: 0.1 to 20% (default 5%). (0.0 set point idles system)
- CO₂ Accuracy: $\pm 0.1\%$
- CO₂ Recovery: Up to 5% +0.2/-0.5 in 5 minutes average.
- CO₂ Display Resolution: 0.1%
- CO₂ Control Logic: Fixed Algorithm/Manual Environmental Adaptable.
- CO₂ Sensor Type: Infrared single source dual wavelength
- Sensor Bay Temp: Chamber Set Point +3.5 Degree C.

Relative Humidity Control: Available on NU-5820 and NU-5841**Performance Determined with O₂ Set Point @ 21.0%**

- RH Range: Low is ambient dependent to 95% maximum (default 90%) (0.0 set point idles the system)
- RH Accuracy: +5% / -3%
- RH Recovery: 90% $\pm 5\%$: 25 minutes on Average
- RH Water tank capacity: 3 Liters (approximate)
- RH Evaporator tank temperature: Chamber temperature Set point +10° C

O₂ control and monitoring system w/ the Fujikura Zirconia sensor Available on the NU-5831 & NU-5841

- O₂ measuring range: 0 to 25 %
- Default Set-Point: 21% (system is idle at this set point)
- O₂ set- point Range: .5 to 21% (2 to 21% when RH setpoint is above 90%)
- O₂ Accuracy: $\pm .25\%$
- O₂ Recovery: 5% $\pm 2\%$: 15 minutes on average

NOTE: Performance ratings apply ONLY when the Incubator is installed and set up properly per the instructions in the manual, has stabilized at all set points and is in a stable environment. See sections 8 and 9 for proper set up.

While idle, the system will not inject gas or RH and will not alarm.

3.4 Standard Items Packed with Unit

- Four (4) stainless steel shelves
- Eight (8) stainless steel shelf brackets
- One (1) water pan
(Note: Water pan is included with units having RH Control System for calibration purposes only. See section 9.5.1)
- Gas supply tube(s)
- Access port plug with breather hole
- One (1), 2 meter (6.5 ft.) electrical cord 10 Amp 18awg with 105°C rated jacket *
- Operation and Maintenance Manual
- Operating Instructions

***Do not replace electrical cord with an inadequately rated cord.
A factory supplied replacement is recommended.**

3.5 Consult factory for additional Accessories (Ordered Separately)

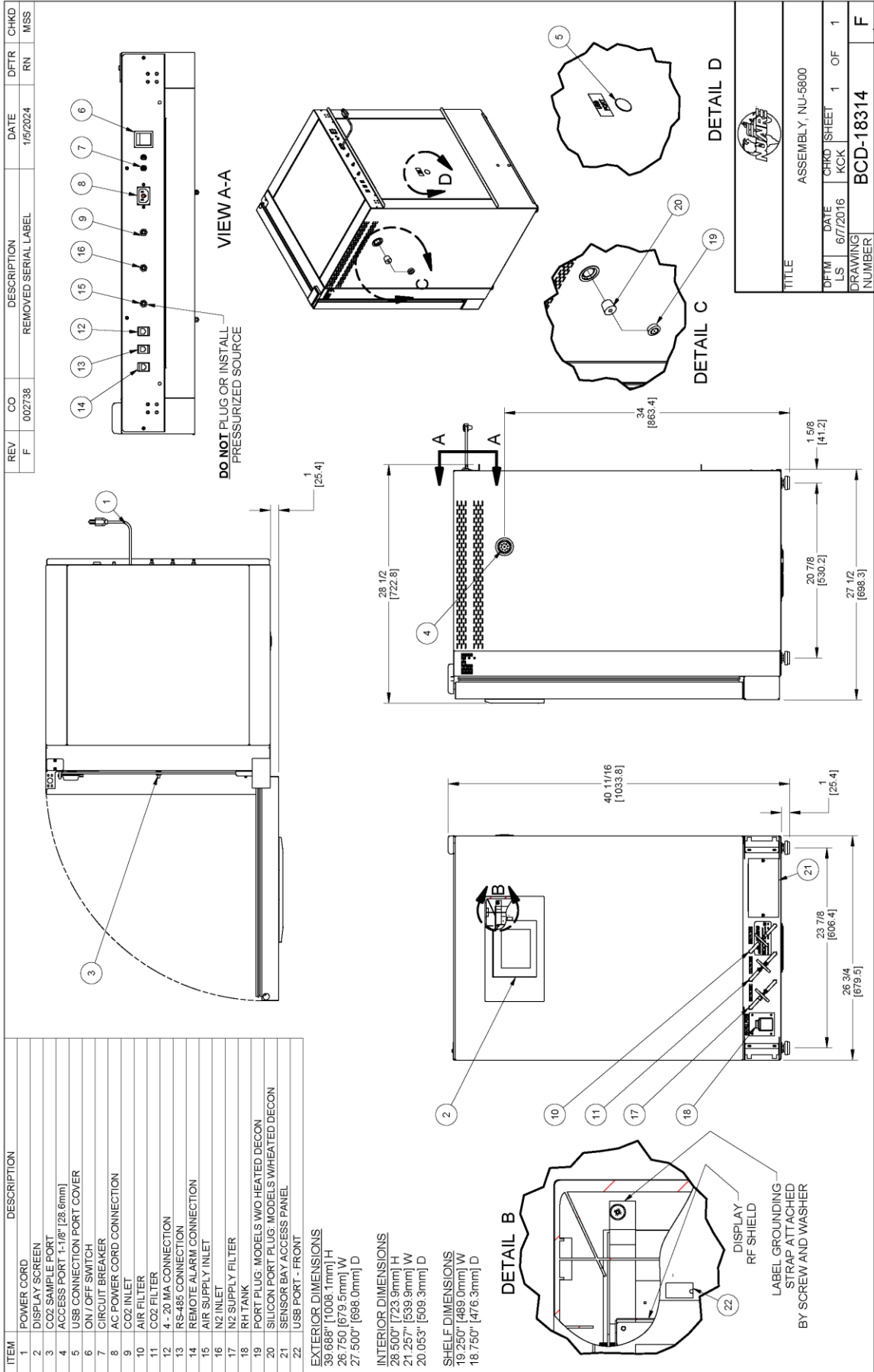

4.0 Test Performance & Procedures

All equipment is thoroughly inspected at the NuAire Factory at the time of shipment. Quality control is maintained by constant surveillance over the product, beginning at the receipt of purchased material and concluding with a final inspection, which certifies the Incubator performance to the specifications. In all instances where product quality cannot be easily assessed on the end item, the product is inspected during sub-assembly fabrication. The following test procedures are conducted on every DHD Incubator, and a copy of the test report is included with each Incubator.

4.1 Visual Inspection

- Each Incubator is visually inspected to ensure that the interior is clean and free from scratches, nicks, and burrs and that all welds, both interior and exterior are finished.
- Painted surfaces are inspected to be free of scratches, nicks, insufficient covering, and noticeable paint runs.
- The doors open and close freely without binding of the hinges.
- The gasket seals the inner glass door to the Incubator tightly across its entire opening.
- The glass door is free of scratches.

4.2 Electrical Tests

- **Electrical Leakage Test**
All Incubators are required to have primary-circuit filtering to meet EMC (electromagnetic compatibility) regulations. Electrical leakage does not exceed 1.0 milliamperes.
- **Dielectric Voltage – Withstand Test**
1200 VDC (115-volt units) or 2000 VDC (230-volt units) is applied between dead metal parts and the hot/neutral power source lead with no electrical breakdown using an Associated Research Model 7564SA Quadchek II, 8106 Omnia 6, or 8006 Omnia 6, or other models.
- **Grounding Continuity**
The resistance between the green bonding conductor of the supply cord and any dead metal part of the cabinet shall not exceed 0.10 ohms.

4.3 Functional Tests

These functional tests are performed on every Incubator over a minimum of a 48-hour /burn-in period. The results are recorded on the final Inspection report and a copy is included with each incubator that is shipped. All failures are noted, corrected, and any failed test is successfully repeated. Changes from any default value of the optional configuration parameters meant to improve performance are recorded on this report for your reference.

- **Control Systems**
All performance and diagnostic functions are exercised to ensure proper operation of control systems, components, and alarms.
- **Temperature**
Each Incubator is monitored for stable temperature control over the 48-hour burn-in period at (37°C).
- **CO₂ Control**
Each Incubator is calibrated to function at a 5% CO₂ level.
The concentration is checked with an independent calibrated instrument.
Each unit is monitored during the 48-hour burn-in period and only accepted with zero failures.
- **CO₂ Recovery**
Each Incubator is exercised for CO₂ recovery time at the end of the 48-hour burn-in period.
The door is opened for 1 minute to deplete the CO₂.
After the door is closed, the unit shall recover to 5% +0.2/- 0.5% within a 5-minute period.
- **Humidity**
Each unit has a default RH level intended to avoid condensation.
Door and perimeter duty cycles are determined by a Base duty cycle calculation based on the chamber Temperature set point. Automatically adjusted in response to environmental conditions but can be manually adjusted if needed to control condensation and tune in the chamber temperature uniformity for the environment that the incubator is installed in.
If unit is master reset these settings will be changed to a default value of 0.0.
The factory default door and perimeter settings are **Door: 0.0, Perimeter: 0.0**.

5.0 Warranty

Details regarding product warranties can be found in the published warranty data separate from this manual and included within the data packet sent with the unit.

6.0 Shipments

NuAire, Inc. takes every reasonable precaution to assure that your Incubator arrives without damage. Motor carriers are carefully selected, and shipping cartons have been specifically designed to ensure your purchase arrives safely and undamaged. However, damage can occur in any shipment and the following paragraph outlines those steps you should take on receipt of a NuAire Incubator to be sure that if damage has occurred, the proper claims and actions are taken immediately.

6.1 Damaged Shipments

6.1.1 Terms are F.O.B. factory, unless stated otherwise.

Therefore, it is important to check each shipment before acceptance.

6.1.2 If there is visible damage, the material can be accepted after the driver makes a notation on the consignee's copy of the freight bill. Then an inspection must be made to verify the claim against the carrier. This inspection is the basis of your filing the claim against the carrier.

6.1.3 If concealed damage is found, it is absolutely necessary to NOTIFY THE FREIGHT AGENT AT ONCE and request an inspection. Without this inspection, the transportation company may not accept a claim for loss or damage. If the carrier will not perform the inspection, an affidavit must be prepared stating that he was contacted on a certain date and that he failed to comply with the request. This, along with other papers in the customer's possession will support the claim.

7.0 Installation

The Incubator is fastened to the base skid, and it is usually the best procedure to leave the skid attached until the Incubator is located in its approximate position to facilitate ease in handling. The base skid can then be removed by removing the two bolts holding the cabinet to the skid. See BCD-18314 for dimensional and feature information about the incubator.

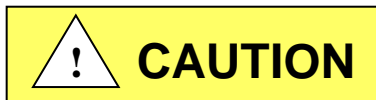

It is recommended that no less than two people are present when the incubator needs to be moved.

Examine the Incubator carefully.

INSPECT both the exterior and the interior for any transit damage before discarding the shipping crate.

7.1 Location

In locating the Incubator, consider all possible conditions that might affect its performance as well as laboratory procedures for its intended purpose. Do not locate near heating or cooling ducts, or next to equipment that generates heat (steam radiators, stoves, ovens, autoclaves, etc.). Avoid direct sunrays and rapidly moving air currents. These conditions adversely affect the even heat dissipation required from the exterior surfaces of the Incubator and may cause the temperature variation in the chamber to exceed specifications as stated in section 3.3. Since the Incubator needs even heat dissipation on all surfaces in order to maintain an internal temperature variation of less than $\pm 0.2^{\circ}\text{C}$, a minimum of 2 inches (50mm) must be allowed between the rear and sides of the Incubator and any walls, partitions or obstructions to facilitate adequate convection of air around the Incubator. Confirm clearance with a tape measure if needed. Adjust the Incubator location accordingly. In addition, the Incubator location should address access to its power cord for connection/disconnection if necessary. For maintenance and service purposes, the control center electronics should remain accessible. Leave at least 3 ft of clearance in front for the swinging door.

NOTE: When locating Incubators side-by-side, they should be spaced at least 10" apart to permit one Incubator to be in a heated Decon Cycle with a minimal heating disturbance on adjacent Incubators running in their normal "run" mode.

7.2 Leveling

Prior to use the incubator should be leveled using a bubble level on a middle shelf in the chamber. The Incubator should have all 4 leveling feet firmly on the bench or floor. Level from side to side and front to back. By turning the adjustable leveling feet counter-clockwise, raises the Incubator.

7.3 Shelf & Water Pan Preparation.

Shelves

The incubator is shipped with the shelves installed. NuAire recommends decontaminating all surfaces within the interior chamber, glass door, and outer door with gasket. They can be wiped down with a disinfectant of 70 percent alcohol or similar non-corrosive antimicrobial agent. Use only disinfectants that are compatible with the vinyl gasket, the powder coat paint on the outer door and the 304L stainless steel in the chamber. See BCD-15169

NOTE: Absolutely no chlorinated or halogen materials are to be used in the chamber.

NOTE: NuAire does not offer any product warranty with respect to cleaning material compatibility. USE AT YOUR OWN RISK! The information provided above is from raw material suppliers and known general source documents for use to develop application cleaning SOP's.

Four (4) shelves are installed in each Incubator. The shelf positions are easily changed by removing the shelf and moving the horizontal guides to the position desired. If the shelf does not bind or disengage from the horizontal bracket it is installed correctly. Additional shelves and shelf guides are available.

Water Pan

Place water pan in the center on the bottom of the chamber and fill with **Single distilled water no purer than 1 Mega Ohm**. It is recommended to fill the pan to a maximum of about 1/2 inch below the top rim. See Sections 3.1 and 8.2 for more specifications and operational details regarding proper maintenance instruction regarding the water.

REV	CO	DESCRIPTION	DATE	DFTR	CHKD
B	002738	UPDATED NOTE	1/8/2024	RN	MSS

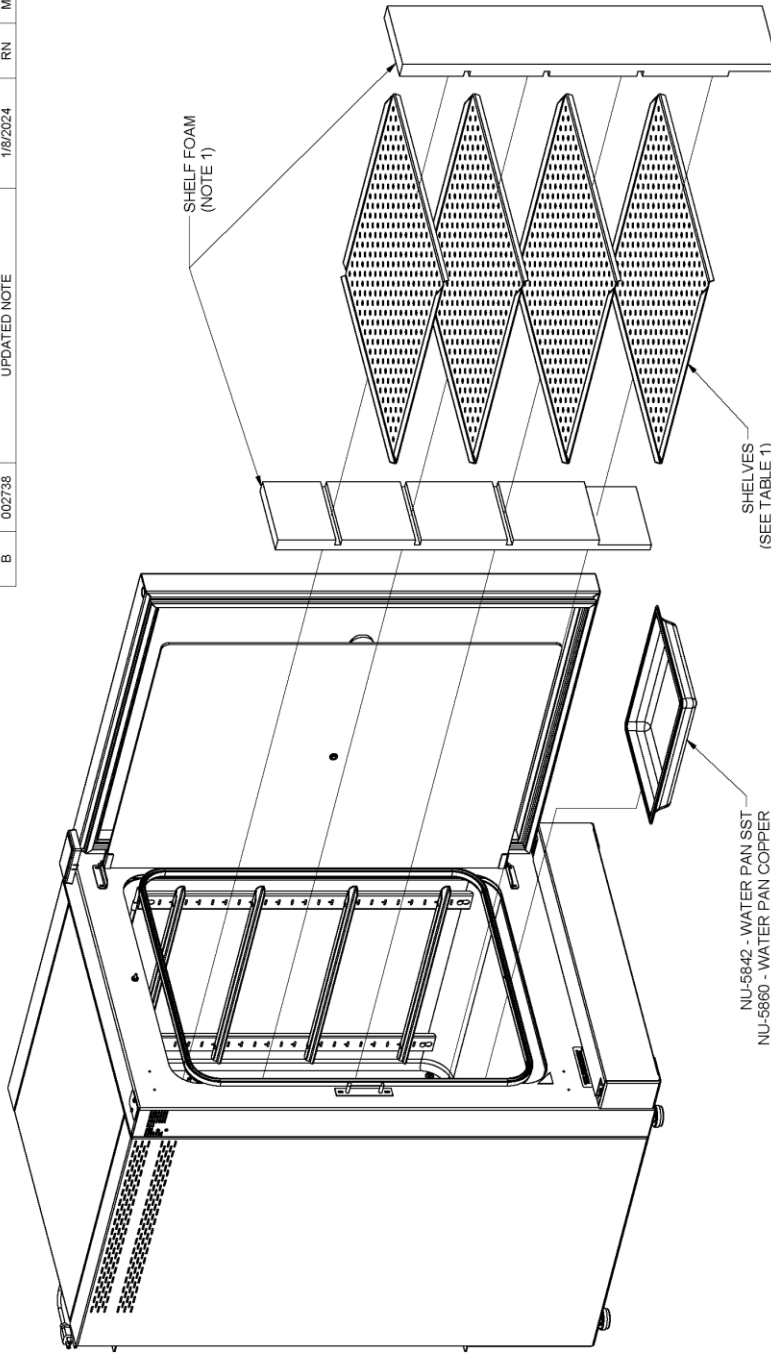

TITLE		DH / D INTERIOR PREP	
DFTR	DATE	CHKD	SHEET
TH	4/17/2018	KCK	1 OF 1
DRAWING NUMBER		BCD-19904	
		B	

TABLE 1: SINGLE SHELF ACCESSORY PACKS			
MATERIAL	200L	160L	
SST	NU-1583	NU-5783	
COPPER	NU-1584	NU-5784	

NOTES:
1. REMOVE FOAM BEFORE INCUBATOR OPERATION.

7.4 Electrical

The electrical supply circuit to the Incubator must conform to all national and local electrical codes.

Consult the serial-data plate, located on front right side of the Incubator, for voltage, cycle, phase, and ampere requirements before making connection. Plug the power cord securely into a grounded power source. **VOLTAGE SHOULD NOT VARY MORE THAN 10% FROM SERIAL PLATE RATINGS.** Have a qualified technician check with the power source with a properly rated voltmeter if needed. A separate branch circuit is recommended to prevent possible loss of product due to overloading or failure of other equipment on the same circuit. **A SURGE PROTECTOR IS STRONGLY RECOMMENDED** to avoid power-related faults.

7.5 Air Inlet Connection

The air inlet and filter are installed at the Factory. The filter has flexible hose that attaches to bulkhead fittings in the bottom of the front panel and can be found under the valance that is beneath the door. One 50mm polypropylene .3-micron HEPA filter is connected to the hoses. The filter is labeled "Air filter". To remove the valance the outer door must be open. Reach in under the valance and lift it to remove. See BCD-18316. The air inlet on the back of the incubator is connected to the filter by a hose at the factory and does not require installation.

CAUTION: This is a free air supply. DO NOT connect to a pressurized air source.

7.6 CO₂ / N₂ Gas Supply Setup

7.6.1 Gas and Air supply HEPA filtering is installed at the factory on the front of the incubator as illustrated in the picture. Each incubator is equipped with the filters required for the control systems available on that model.



- **CO₂/N₂ Pressure to the Invitrocell is rated at 20 PSIG or 1.4 BAR. Do not exceed 25 PSIG or 1.8 BAR to avoid damaging the incubator.**
- CO₂/N₂ of medical grade is recommended.
- A two-stage pressure regulator, Linde #19590 (NU-1564) or equal is recommended.
- **DO NOT USE a single stage regulator.**

7.6.2 CO₂/ N₂ Gas Supply Tubing Connections

Included with this unit and for all models of the 5800 series is (1) six-foot (2 m) of vinyl tube.

It connects between the low-pressure side of the 2-stage regulator at the CO₂ supply and incubator fitting labeled **CO₂ INLET** (as shown in the following Figure). Next, secure each connection with the clamps supplied.

On Models NU-5831 and NU-5841 there is a second six foot (2 m) of vinyl tube.

It connects between the low-pressure side of the 2-stage regulator at the N₂ supply gas and incubator fitting labeled

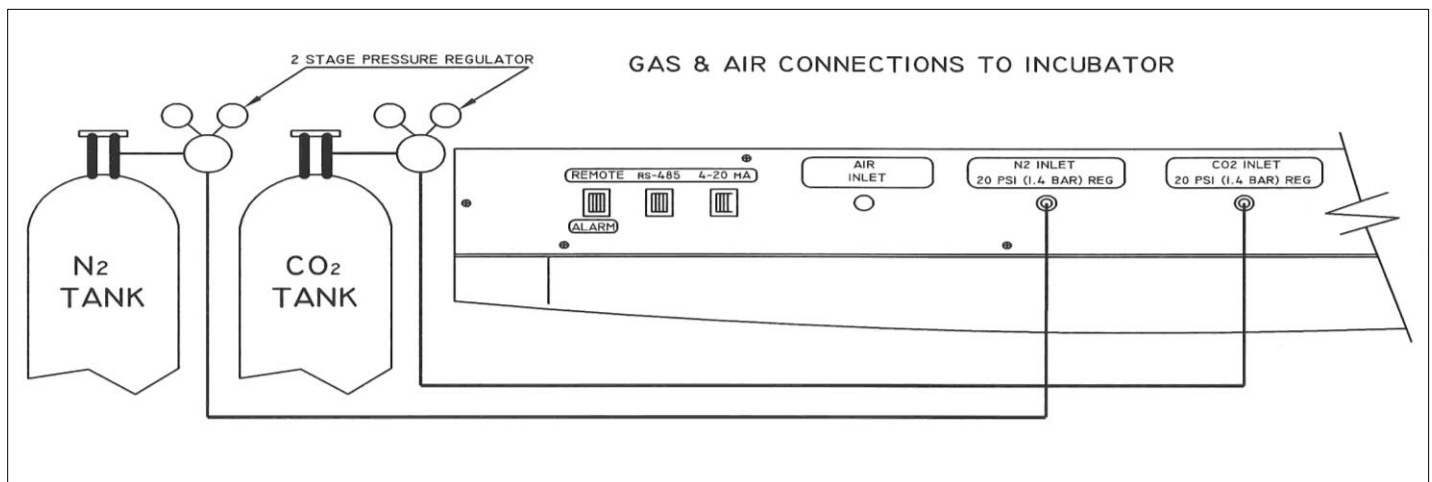

N₂ INLET. Next, secure each connection with the clamps supplied.

Figure illustrating CO₂ and N₂ gas supply connections.

7.6.3 CO₂/ N₂ Supply

- CO₂/ N₂ of medical grade is recommended.
- A two-stage pressure regulator, Linde # 19590, or equal, is recommended.
- DO NOT USE a single stage regulator.

It will not give a stable output at 20 psi and exposes the Incubator to the gas cylinder pressure.



- **High concentrations of CO₂ gas can cause asphyxiation!**
- **Install Incubator in a well-ventilated area.**
- **Gas Supply pressure to the Invitrocell is rated at 20psi (1.4 bar).**
- **Do not exceed 25psi (1.8 bar) or damage to the incubator may occur.**

This Incubator is designed to be operated with CO₂ gas only.

Connecting a flammable or toxic gas can result in a hazardous condition.

Gases other than CO₂/ N₂ should not be connected to this equipment.

CO₂ gas cylinders have a UN1013 label on the cylinder and are equipped with a CGA 320 outlet valve.

Check the gas cylinder for the proper identification labels.

Do not use CO₂ gas cylinders equipped with siphon tubes.

A siphon tube is used to extract liquid CO₂ from the cylinder which can damage the pressure regulator.

Consult with your gas supplier to ensure that the CO₂ cylinder does not contain a siphon tube.

7.6.4 CO₂/ N₂ Pressure Regulators

The regulator's high-pressure stage direct from the supply cylinder must have a range of from 0 to 2000 PSI or 0 to 140 BAR. This gauge indicates actual tank pressure.

The low-pressure stage should have a range of 0 to 30 PSI or 0 to 2 BAR (100 PSI or 6 BARS maximum). This gauge will indicate the actual CO₂/N₂ pressure to the Incubator.

Some single stage CO₂/N₂ pressure regulators have two gauges. **USE A TWO-STAGE REGULATOR.**

All NuAire Incubators use CO₂/N₂ in such quantities that precise metering of CO₂/N₂ input pressure is important for maximum performance.

To connect the regulator:

- First: Open the CO₂ cylinder slightly, for an instant (this is termed "cracking the valve.") This will blow out dust or dirt that may have collected in the valve outlet.
BE SURE to keep your face away from the valve outlet to protect your eyes from dust or dirt.
- Second: Make sure the regulator pressure-adjusting screw is released by turning it counterclockwise until it turns freely.
- Third: Attach the regulator to the cylinder valve and tighten the connection nut with a wrench.
BE SURE DISC SEAL IS IN PLACE BEFORE MAKING CONNECTION.

7.6.5 CO₂/ N₂ Supply Adjustment

With the regulator OFF (i.e. fully counterclockwise), open the cylinder valve slowly usually 1 to 2 turns is sufficient.

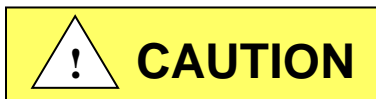

NEVER STAND IN FRONT OR BEHIND THE REGULATOR WHEN OPENING THE VALVE. ALWAYS STAND TO ONE SIDE.

The cylinder tank pressure should read: 700 to 800 PSI (48 to 55 BAR) for CO₂ or 2550 to 2650 PSI (176 to 183 BAR) for N₂ more or less depending on the temperature of the cylinder.

Next turn each regulator's pressure adjusting knob clockwise until the low-pressure gauge reads 20 PSI or 1.4 BAR.

Both gas connections are now complete.

NOTE: OSHA requires the CO₂ tanks to be physically restrained (i.e. via chained to wall) to prevent accidental damage to cylinder.

7.6.6 Checking the Connections

The connections can be checked for leakage by brushing a small amount of soapy water on each one.

Observe to see if any bubbles are blown. If not the connection is secured properly.

If it is, the cause of the leaking needs to be determined, (i.e. loose clamp or damaged hose) and corrected.

7.7 Removing the cable tie used to secure the air pump for shipping:

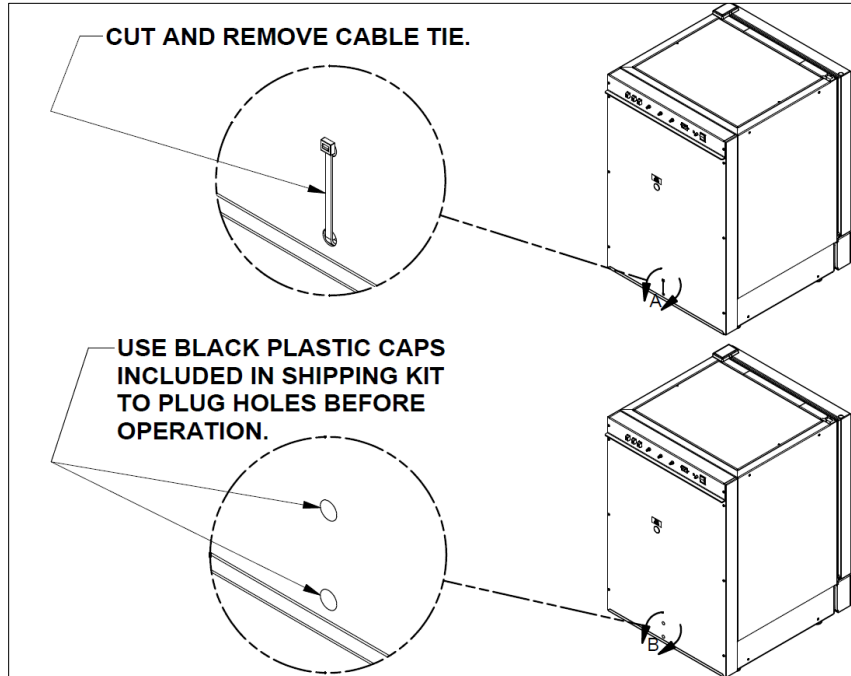

7.8 Setting up the access port:

When utilizing the access port do not block or restrict the relief holes in the center of the port plug. Blocking this venting can cause performance issues for the incubator. Cut slits or new holes in the vented plug to make passage for cables or other items requiring access to the chamber if needed.

7.9 Correct Installation

When the Incubator is installed correctly connected to the power source it is rated for gas connections made properly, the water pan filled, the shelves in place, and the unit is leveled. Read section 8 and follow all instructions for setting set points at the desired value. Then calibrate the Incubator control systems as explained in section 9. If the Incubator is installed and calibrated correctly it will meet the performance specs listed in section 3.3.

7.10 Reversing Incubator Hinges

Reversing the incubator hinges from the right to the left side SEE PTB0236 for instructions. This requires disassembly of the incubator and should be done by a qualified service technician.

8.0 DHD Operation



ATTENTION ACCOMPANY'S INFORMATION OR IMPORTANT SYMBOL

191



POTENTIAL ELECTRICAL HAZARD ONLY QUALIFIED PERSON TO ACCESS

188



HOT SURFACE BURN POTENTIAL

564

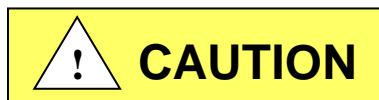

Safety alert symbol indicates potentially hazardous Situation which, if not avoided, may result in minor Or Moderate injury.

CAUTION: A qualified technician who is familiar with the proper maintenance procedures required for this equipment, as well as repair must perform all maintenance actions on this equipment.

The Incubator is designed to provide a sterile, constant temperature, constant CO₂ level and naturally humidified atmosphere for optimum growth of tissue cell cultures and other organisms requiring this precise environment. To operate the Incubator properly, the following parameters must be reviewed, carefully set, and/or prepared.

8.1 Sterility

The chamber environment is not selective. The growth environment is applied equally to all microorganisms (specimens and contaminants) within the chamber. Therefore, before placing any cultures in the Incubator, the shelves and sidewall top plenums should be sterilized. The interior sidewalls, top, bottom, door, as well as the gasket should be wiped clean with a 70% solution of isopropyl alcohol or other disinfectant compatible with the chamber construction, to remove any contamination. Use mild detergent to clean the exterior of the Incubator. This Incubator provides the lab professional with a choice of 2 heated decontamination cycles. (See section 10.1 for further information.)

NOTE: NuAire does not offer any product warranty with respect to cleaning material compatibility. **USE AT YOUR OWN RISK!** The information provided above is from raw material suppliers and known general source documents for use to develop application cleaning SOP's.

8.2 Humidity

Water Pan available on all Models

Humidification of the Incubator chamber is achieved through the process of water evaporation (vapor water pressure) from a stainless-steel water pan placed on the bottom of the chamber. Materials of different thermal resistance (e.g., glass, plastic) do not offer sufficient thermal recovery and are not recommended for water pan usage. Although some metals offer better thermal coefficients than stainless steel, dissimilar metals cause electrolysis in the acid atmosphere (carbonic acid) and should never be used or placed within the chamber.

Use only distilled or mineral-free water, **no purer than 1 megaohm**, in the stainless-steel pan. The water should be changed at least once a week. FLOODING THE BOTTOM OF THE INCUBATOR IS NOT RECOMMENDED since it is difficult to change the water weekly and almost always necessitates the use of chemicals, which are not recommended and may damage the stainless steel. Also, it promotes condensation on the inner walls because it steals the natural convection, heat flow through the inner chamber and condensation points occur.

NOTE: ABSOLUTELY NO CHLORINATED OR HALOGEN MATERIALS ARE TO BE USED IN THE CHAMBER.

Humidity Recovery: Using the water pan supplied with the incubator and with a 5.0% CO₂ set point.

NU-5810: After a 15 second door opening RH recovers to 90% of what the RH level was prior to opening the door for 15 seconds in 20-40 minutes on average.

NU-5831: Recovery after a door opening is directly dependent on the O₂ set point and ambient RH. The lower each of these factors is the longer the recovery time.

Contamination in the water pan may be avoided by adding a small amount of copper sulfate to the water pan after each Incubator decontamination.

NOTE: Please contact the copper sulfate manufacturer to determine the proper amount of copper sulfate that should be added to the water pan.

Condensation on the glass door, walls, top, or bottom of the chamber indicates an incorrect balance of door and front perimeter heat. Both the door and front perimeter heaters operate on a duty cycle. A good starting point for these duty cycles is the default setting for the door & perimeter heaters in a room ambient temp of 22°C (72°F) at a temperature set point of 37.0°C. The fresh airflow that the air pump delivers to the chamber has been preset at the factory. If condensation starts forming on the sides or back wall in the chamber, the number and length of air injections into the chamber can be increased. (See section 9.3 for instructions.) To alleviate the condensation, increase the airflow. To increase RH in the chamber, reduce the airflow. If airflow is decreased, some condensation may be unavoidable. The port plug with breather hole must be used on the side port.

Humidity Monitoring and control systems are available on Models NU-5820 and NU-5841.

These models humidify the chamber by circulating the chamber air through heated water vapor saturated air in a tank located outside of the chamber. This gives the operator control over the amount of humidity in the chamber from an ambient dependent low value to 95%. After a door opening, the recovery time to 90% +5% / -3% is 25 minutes on average. The control system has a ±3% accuracy from any given set-point 90% and below. Much of the information regarding the water pan can be applied with the exception of the water pan.

RH setpoints exceeding 90% will limit the O2 setpoint input (on 5841 models) to a minimum of 2%.

NOTE: Contamination of the water in the RH tank is avoided by a copper stem that is mounted in the RH tank. This copper stem prevents the RH tank from inhibiting bacterial growth.

The control system uses a solid-state capacitance humidity sensor to monitor the relative humidity within the chamber. If humidity is required, the control system will activate a solenoid valve routing the chamber air through a humidified heated enclosure just before being returned to the chamber. The control will continue rout the chamber air through the water vapor saturated air until the set-point is achieved. Use only single distilled water, **NO PURER THAN 1 MEGA OHM** to fill the reservoir. The relative humidity display and control option offers an accurate and reliable method to control humidity when required. The alarm set-point defaults at 8% over the set-point and 3% below.

NOTE: DO NOT SEAL OR RESTRICT THE OPENING IN THE PORT PLUG.

THIS IS A PRESSURE RELIEF FOR THE CHAMBER.

8.3 Control System Introduction

The NuAire Incubator Control Electronics system is designed to serve the control requirements of the Incubator chamber. Temperature, CO₂ levels in all models and RH & O₂ in available models are controlled by preset values to provide the optimum conditions for culture growth within a chamber. Operator input is coordinated through the NuTouch LCD keypad and status displays.

Figure 1 shows the various inputs and outputs of the system.

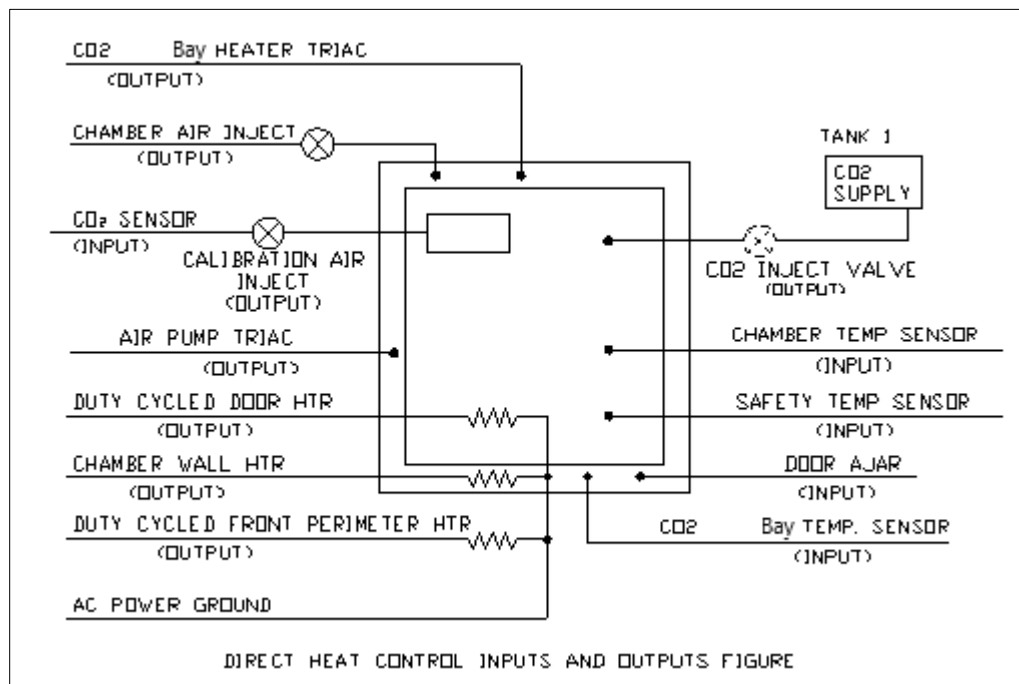

8.3.1 Chamber control in a single electronic package.

8.3.2 Enhanced information presentation on a NuTouch LCD

Main Screen Continuously displays:

- Measured Chamber Temperature
- Measured CO₂ %
- Measured RH % in Available models
- Measured O₂ % in available models
- Current Screen ID "MAIN SCREEN"
- A mode status indicator (RUN, STANDBY or Power loss Recovery)
- Door ajar status displays when door is ajar
- Door Closed status displays when door is closed and flashes during the post door close delay time.

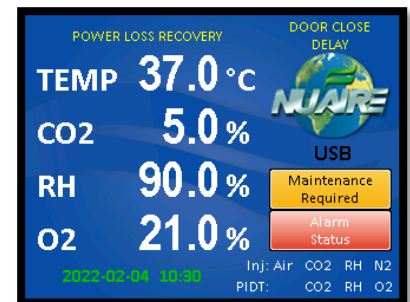

- NuAire Logo button Leads to the System settings menu when pressed
- Date and Time
- Air, CO₂, RH, & O₂ inject indicators show when gas or RH is injecting.
- PIDT: CO₂, RH, & O₂ indicate that the system showing is in Post Inject Delay Time.
- A heated Decon Cycle display
- An Alarm Status Menu
- Maintenance Required displayed

8.3.3 Active buttons on the MAIN SCREEN:

Button Description	Action when touched
Control system description (i.e.....TEMP or CO ₂)	Brings a pop up screen that describes the control system that was touched
Measured value of each control system	Goes to the Environmental Set Point Screen (Key pad to enter password will pop up if the password function is enabled)
NuAire Logo	Goes to "System Settings" Screen for access to more menus
Date & time display	Goes to screen for adjusting time and date

8.3.4 Accessing the Incubator Control Screens

Accessing the many Control screens, performing functions and diagnostic tests, and maneuvering through the NuTouch LCD menu system is accomplished through the following methods:

- Touching a "graphic" Icon like the NuAire Logo in the Main Screen which access the System Settings menu, or lead you to an Enter Password screen when a password has been established.
- Touching a "Button function" button command that is visible on the screen. The button will have text in it indication the function you are about to perform.

The following buttons are used:



An explanation of these buttons is as follows:

- Save** - This command saves the changes you have made and returns you to the calling screen or, in some cases, back to the main menu.
 - Exit** - This command exits you from the current screen and returns you to the calling screen.
 - Close** - The command causes the current screen to be removed and returns back to the calling screen.
 - Back** - This command returns you to the previous screen.
 - Start** - This command causes a main event to begin (e.g. Decon Cycle).
 - Next** - This command causes another step (screen), in a list of steps (screens) to be displayed (e.g., Decon cycles and some CO₂ calibration screens).
 - Decon** - This command begins the Decon sequence.
 - Cancel** - This command will cancel the changes you have made, and in some circumstances, cancels the "set of requests" that you have entered and returns you back to the calling screen. (e.g., cancel in the middle of the Decon screen setup returns you to the calling screen)
- Touching a "Text" button command. The text or numerical value will be in blue indicating that is a link similar to the computer or on the internet. The system settings menu screen shown below is a good example of both the Text commands and Button commands:

NOTE: The Main Screen is the one exception for the above described buttons.

The green clock text is and is a link to adjusting the time.

The large white Control system measured values are also a "second" link to the "Environmental Set-Points" menu and the control system descriptions are a link to system description pop up screens when touched.

8.3.5 Functioning accessed from the System Settings screen:

The “System Settings” menu screen can be accessed from the “Main Screen” by touching the NUAIRE logo:

Environmental Set-Points: Allows adjustment of Temperature, CO₂, Door, and Perimeter heater power level settings.

NOTE: You can also access the Environmental set points by touching any control system numerical value in the MAIN SCREEN.

- Performance Monitor:** Views a function’s Set-Point and Measured values over the last seven days.
- Service Settings:** Protected by the password 9876, it facilitates Calibrations, Option settings, and access to Diagnostics.
- System Information:** Views the units Model Number, Serial Number, Control board assembly (CCBA) Software Revision and the Display board assembly (LCBA) Software Revision.
- Display Settings:**
- Brightness:** Allows adjustment of the screen brightness. Slide right to increase / left to decrease
 - Calibrate:** Press button to access screen calibration - follow screen prompts / target symbols.
 - Save:** Remember to press the “Save” button after making changes or calibrating the screen. They will be lost if “Cancel” is pressed to exit the screen.
- Set Password:** A 4 digit password can be set and will protect access to Environmental Set points, running Decon cycles, and changing the password. See section 8.3.7 for instructions to set the User Password.
- Decon:** Begins Decon setup instructions and starts the heated Decon Cycle when pressed. Also, it advances through the phases of the Decon Cycle.

System Settings Screen



8.3.6 Automatic notification of abnormal situations (See Section 11 for details)

The red “Alarm Status” text message (button) will appear on the Main Screen to indicate a fault within the Incubator system. An audible alarm is also heard. The audible alarm is on for 10 seconds at the beginning of an alarm condition and thereafter, it will be on 1 second every 30 seconds.

By depressing (touching) the Alarm Status text on the Main Screen, you now reach the Incubator Alarm Status screen which will identify which Incubator sub-systems are in an alarm state (Temperature, CO₂, or General). You may exit the screen or touch any of the sub-system buttons which will give you more specific information on alarm conditions. See Section 11.0 for more specifics on alarm conditions.

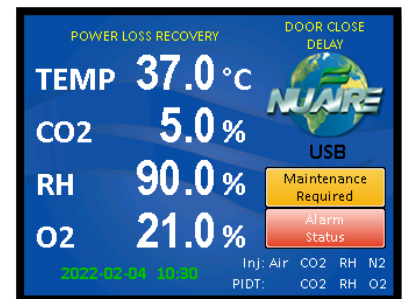

8.3.7 Password Protection

There are 2 levels of password protection.

1. The permanent numerical password required for accessing the “Service Settings” menu screen.
This screen is accessed by pressing the “Service Settings” text Icon in the “System Settings” menu screen.

The password is

9 8 7 6

 and it cannot be changed or deleted.

The functions in the “Service Settings” screen are intended to be used by qualified technicians to calibrate the control system sensors like Temperature and CO₂, adjust optional parameter settings to customize incubator performance, perform system diagnostics and to Factory or Master reset for returning the incubator to Default settings.

2. A selectable 4 digit numerical password that is entered by the Incubator user to prevent others that are not authorized to change the Incubator set points (CO₂%, Temp), running conditions of the Incubator, initiate a Decon Cycle or changing passwords. The password protection may be initiated by accessing the “Set Password” menu in the System Settings menu screen. Once initiated, a four digit number must be entered, then re-entered for verification.

8.3.8 Standard remote communication capability

The Incubator comes equipped with the following remote communication tools:

- USB Output of daily, weekly & monthly performance logs and an event log that indicates when alarms, door openings and power interruptions occur.
- 4-20 milliamp analog Output
- RS-485 2 way communications
- A USB method of updating the software

8.3.9 Diagnostic and calibration assists.

To access the Service Settings Menu, perform the following steps: NuAire Logo → Service Settings → 9876 Enter. You are now in the Service Settings Menu (screen). This screen provides you the capability to review and analyze numerous Incubator functions including the following:

- Individual analog inputs may be displayed to assist calibration.
- Individual outputs may be forced to an on or off condition.
- Individual digital inputs may be displayed.
- Calibrated and Uncalibrated values are displayed.
- All options may be individually tested.

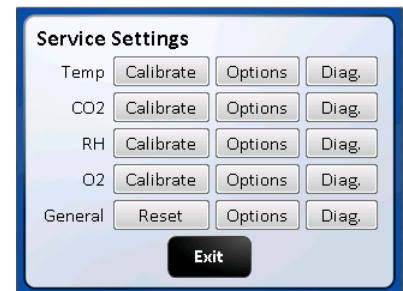

8.4 NuTouch Display Screen

The system LCD touch screen has the following functions.

8.4.1 Front LCD touch screen Descriptions

The NuTouch LCD allows the user to access a wide variety of unit configurations and diagnostic menus by touching the NuAire logo icon.

The Main Screen displays:

- Power Interrupted message displayed when power is lost and then re-connected
- Current Calibrated values of enabled control systems
- Current operating mode (run, standby or Power loss recovery)
- Door Ajar, Alarms, and Maintenance notices

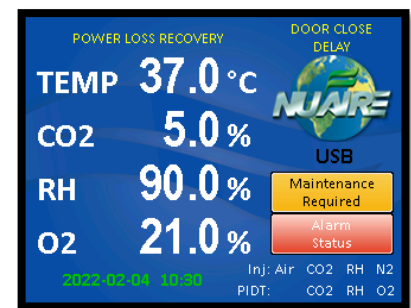

8.4.2 Inject CO₂ / O₂ / RH Status

On the bottom right of 'Main' screen, "CO₂ / O₂ / RH" text indicates when the inject valve is open and the gas or RH is flowing into the chamber maintain set point for each of the control systems. Each text icon appears independently when that System is actively injecting.

8.4.3 Post Inject Delay Time (PIDT)

On the bottom right of the 'Main' screen just below the inject status icons from 8.4.2, "CO₂ / O₂ / RH" text indicates when these systems are in post inject time after the injection is done. Each text icon appears independently when that system is in the delay time.

8.4.4 Inject Air Status

On the bottom right of the Main screen "Air" text indicates that fresh air is currently being injected into the chamber.

8.4.5 Door Ajar Status

The door ajar white text message indicates when the inner glass door is not closed and latched; the inner glass door is open. The door ajar status is a result of the pressure switch (open/closed) located along the top middle of the front panel. After the door is closed, the text will display "Door Closed Delay" indicating the delay time (60 sec adjustable).

8.4.6 Power interruption notice

Indicates that the power has been interrupted. Touch text to acknowledge and Nuair Logo will reappear.

8.4.7 USB status

The USB status icon appears in the lower right side of the Main screen when a memory stick is placed in the USB port at the back of the unit while downloading performance and event history. This icon disappears when the memory stick is removed from the port.

CAUTION: When a memory stick is placed in the USB port it can interfere with the RS-485 communication output. The RS-485 communication may have to be restarted after the memory stick is removed from the port.

8.4.8 Maintenance Required Notice

The Maintenance required notice appears in the middle of the right side of the screen indicating that either the RH water tank needs to be filled or that it is time to check the capsule filter in the Sensor bay. Press the notification button to bring up the screen that indicates the maintenance that is required.

8.4.9 Alarm Status Notice

The "Alarm Status" button indicates an abnormal status condition.

This text appears just above the AIR CO₂ status messages (paragraphs 8.4.2 and 8.4.3). The "Alarm Status" button and audible alarm indicate the abnormality. A catastrophic temperature control condition will de-energize the safety relay and cause the chamber to cool below the set point. The unit will resume heating when it has recovered from the abnormality. See sections 8.3.6 and 11.0 for more details on Alarms.

8.5 Rear Component Panel Detail

The rear control panel contains the following functions. BDC-15170

8.5.1 Power Cord

The power cord is 6.5-foot (2 m) in length, type "SVT" molded plug, allowing for long life and easy cleaning.

8.5.2 Circuit Breaker

All control electronics are protected with a circuit breaker that may trip at 110% of load rating but will trip at 145% of load rating in less than 2 seconds.

Should the circuit breaker open (pop-out button will appear), merely depress to reset.

8.5.3 N₂ Inlet on NU-5831 and NU-5841

The N₂ inlet provides a fitting for vinyl tubing for oxygen control.

Be sure to follow the recommended inlet pressure to ensure proper flow rates and consistent O₂ percentage readings.

8.5.4 CO₂ Inlet All models

The CO₂ inlet provides a fitting for vinyl tubing.

Be sure to follow the recommended inlet pressure to ensure proper flow rates and consistent CO₂ percentage readings.

Power Switch

The power switch, located at the top of the rear panel, controls all power to the Incubator.

8.5.5 Standard Communication Interface's / Alarm

Three receptacle connectors are provided for direct field connection of a computer for 2-way communications and incubator monitoring/or output to a printer or other device only capable of receiving RS-485 digital information, dry contact remote alarm indicator, also 4 to 20 mA output to an analog monitoring device or system. All come standard and ready to use. See section 12 for more detail.

8.5.7 Air Inlet (All Models)

This is a free air supply.

DO NOT CONNECT TO A PRESSURIZED SOURCE.

Air filter is installed at the factory on the front of the unit.

REV	CO	DESCRIPTION	DATE	DFTR	CHKD
E	002738	REMOVED PART NUMBERS	1/5/2024	RN	MSS

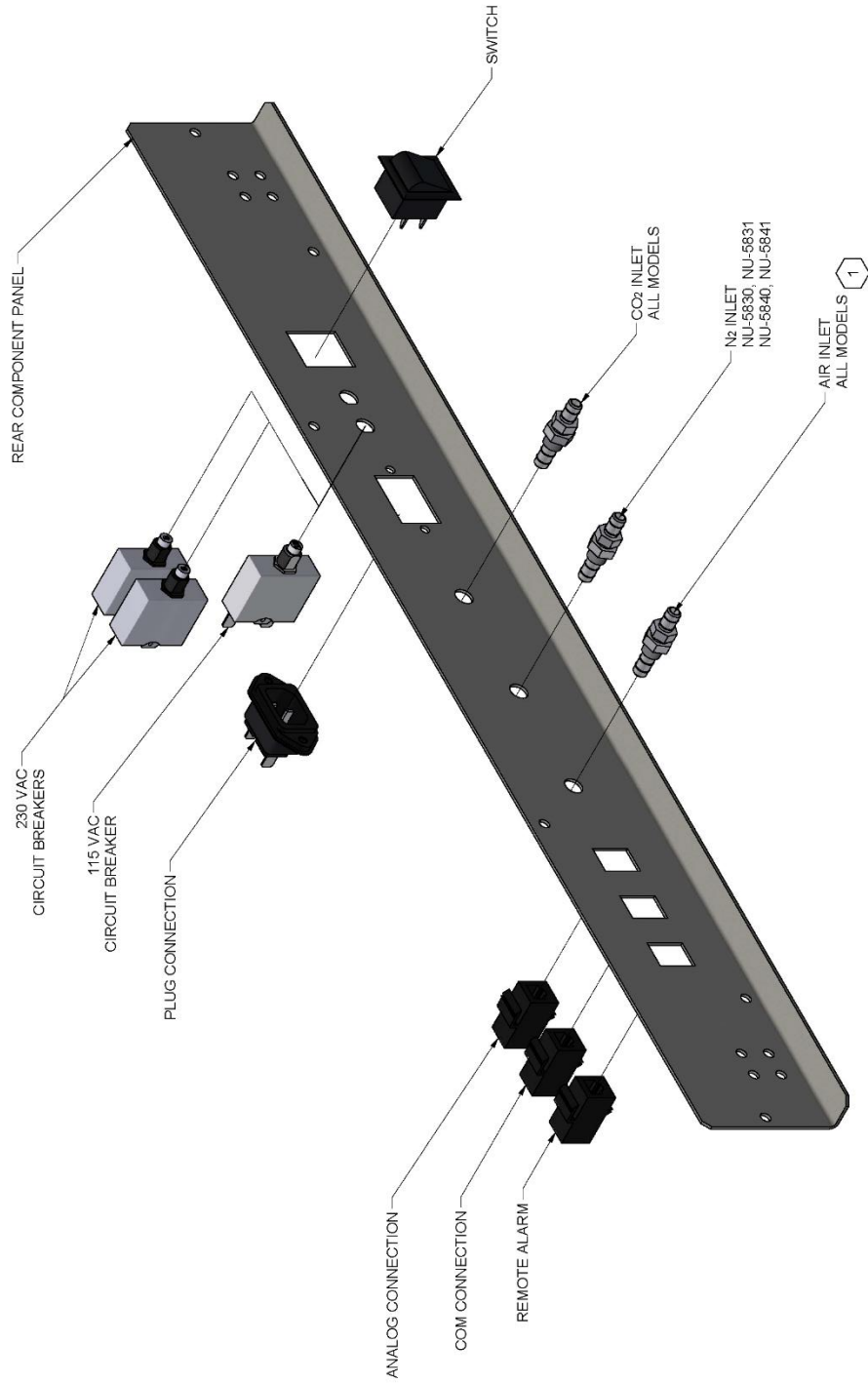

TITLE REAR PANEL ASSEMBLY					
DATE	CHKD	SHEET	1	OF	1
3/1/2012	KCK				
DRAWING NUMBER					E
					BCD-15170

NOTES:
 1 AIR FILTER INSTALLED AT FACTORY ON FRONT OF INCUBATOR.

8.6 Front Component Panel

The front component panel contains the following functions. BCD-18316

8.6.1 RH Fill Port (Available on models NU-5820 and NU-5841)

The RH evaporator tank is filled through the port that has the red plug (w O-ring) screwed in it. Because of the pressure in the evaporator tank during an RH injection the O-Ring must seal against the top of the fill port.

8.6.2 N₂ Supply filter (Available on models NU-5831 and NU-5841)

The N₂ supply filter is installed at the factory and should be changed following the instructions found in Maintenance Section 10.

8.6.3 CO₂ Supply Filter

The CO₂ supply filter is installed at the factory and should be changed following the instructions found in Maintenance Section 10.

8.6.4 Air Inlet Filter - All models

The air inlet filter is installed at the factory and should be changed following the instructions found in Maintenance Section 10. This is a free air supply.

NOTE: DO NOT CONNECT TO A PRESSURIZED SOURCE.

8.6.5 Chamber sample port

The Sample port is provided for checking the CO₂ level in the chamber to monitor the calibration the Sensor and determine if it needs adjustment. It is located in the middle of the inner glass door.

8.6.6 Sensor Bay Access Panel

Provides access to the CO₂ sensor, Capsule Filter, and the Hydrophonic filter for maintenance.

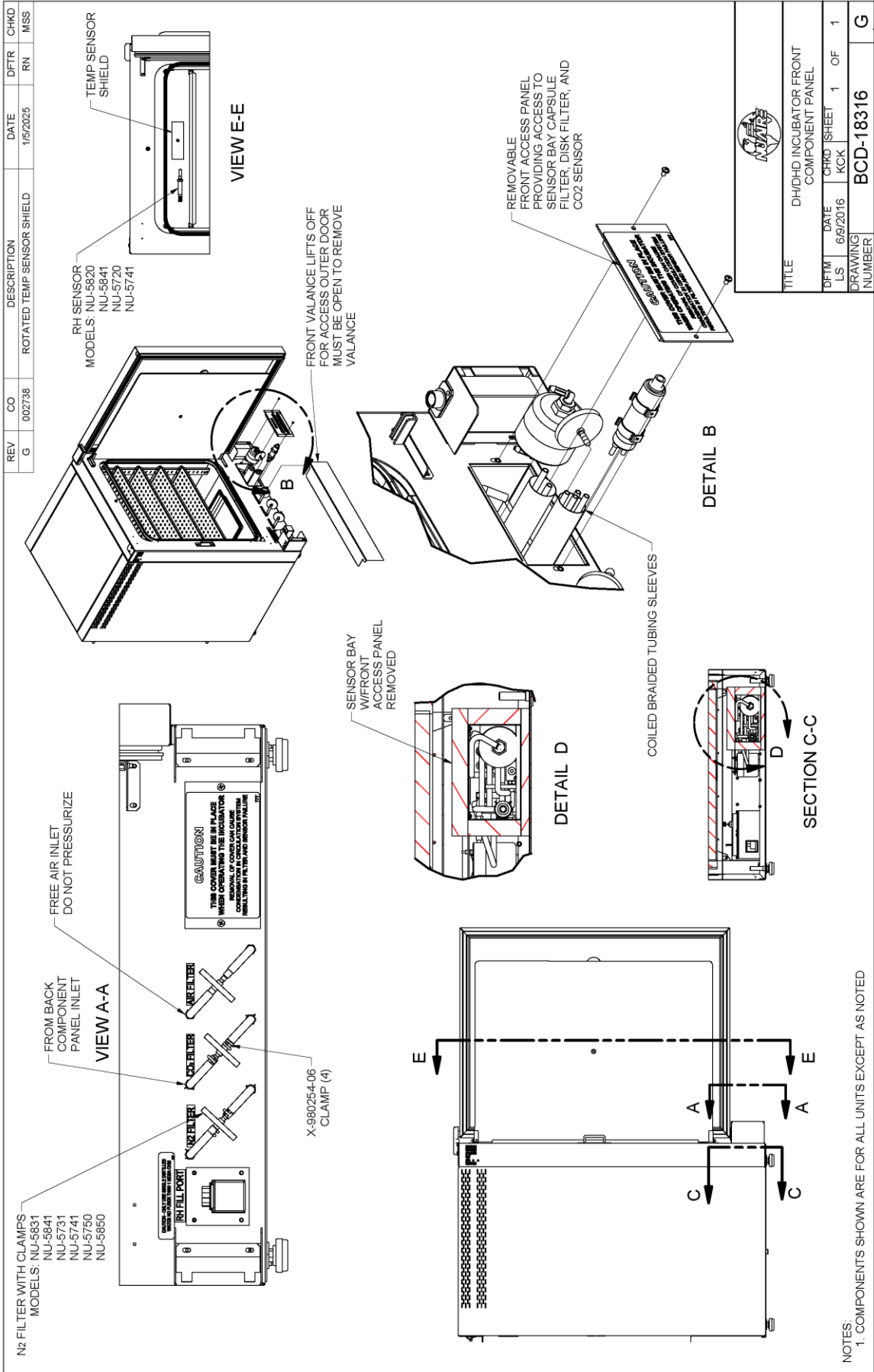

TITLE			
DH/DHD INCUBATOR FRONT COMPONENT PANEL			
DFTR	DATE	CHKD	SHEET
LS	6/9/2016	KCK	1 OF 1
DRAWING NUMBER			G
			BCD-18316

8.7 Run Mode Operator Interactions

8.7.1 THE FIRST TIME THE INCUBATOR IS TURNED ON

- The NuTouch boot up screen appears then shows a screen instructing you to “Read the manual and follow all instructions to properly install the incubator” Both screens will automatically advance after 5 minutes. To manually advance:
 - Press the exit button then a thank you screen will appear.
 - Press the “Continue” button then the unit will go to the “MAIN SCREEN”.

These screens will not show again unless you “MASTER RESET” the incubator control board.

- Setting the Clock

8.7.1.1 Clock display organization:

YYYY-MM-DD HR: Min and is displayed in green text in the lower left of the display screen.

8.7.1.2 Press the green text and the Time and date adjustment screen appears.

After a power interruption the date and time will flash as follows:

- Green text indicates there was a power interruption but the real time clock remained powered. Press the flashing text to bring up the “set the clock” screen. If no change is needed press cancel to go back to the main screen. Otherwise make the required changes then, press the save button to save the changes and return to the main screen.
- Yellow text indicates the real time clock lost the backup power and the date and time need to be reset. Press the flashing text to bring up the date/time setting screen

8.7.1.3 Use the up/down arrows to increase or decrease the highlighted value.

Use the left/right arrows to move between date and time values that require changing.

8.7.1.4 Press “Save” to save the changes you just made or

Press “Cancel” to abort the changes and return to the main screen.

The mode display, on the ‘Main’ screen, is used to identify the mode of chamber operation: either standby or run. In general, there is no need for operator interaction in "run" mode. However, operator interaction is required when the incubator is first turned on then to perform calibration functions and address abnormal conditions status. If an abnormal condition has, or does, exist for a particular parameter, an alarm becomes active and the ‘Alarm Status’ button will appear. This could be a catastrophic alarm condition, which could harm the tissue culture cells. It does indicate an operational abnormality and should be checked. To acknowledge the abnormality, simply press the “Alarm Status’ button to view the alarm, to dismiss it press the corresponding alarm’s button. The audio and visual alarms will then extinguish. If the abnormality still exists, the return after waiting the specified alarm time.

Let the Incubator run normally, and if the alarm doesn't come back on, then everything is normal. If the alarm does come back on, use the troubleshooting guide to correct the abnormality (see Section 11.0).

8.8 Standby Mode Operator Interactions

The NuAire incubator automatically enters the standby mode when necessary.

There is no action required by the user to enter this mode.

All functions that put the incubator in standby mode automatically start a 1 minute timer.

If the function is not interfaced through the screen on the NuTouch display, the incubator then returns to the MAIN SCREEN and switches to RUN mode.

8.8.1 Chamber Temperature, CO₂%, Relative Humidity %, & O₂% Set- points

8.8.1.1 Accessing the Environmental Set point screen used to manage set points is done one of two ways:

- Press any control system value displayed in the main screen.
- Press the NuAire logo then press the Environmental Set Point text in the Systems Settings screen

8.8.1.2 Pressing the blue numerical value next to the control system that you intend to change will bring up a number keypad. Punch in the new value and hit the “Enter” key to leave the keypad and return to the Set-point screen. You will be asked if you want to save the new set point(s) when you press Exit to leave the set point screen and return to the Main screen.

Press “Save” to retain the changes.

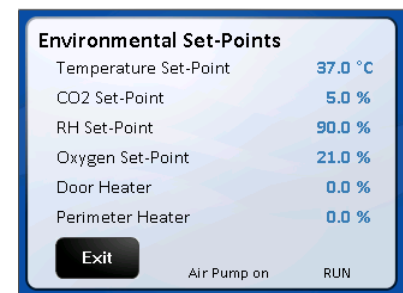

Environmental Set-Points	
Temperature Set-Point	37.0 °C
CO ₂ Set-Point	5.0 %
RH Set-Point	90.0 %
Oxygen Set-Point	21.0 %
Door Heater	0.0 %
Perimeter Heater	0.0 %

Exit Air Pump on RUN

8.8.1.3 Default Set points

Temperature	37.0 C		All Models
CO ₂	5.0%	Note 1: A set point of 0 (zero) will put the system into an Idle state where it does not control and all alarms are inhibited. The sensor remains active and reports the level of gas/RH in the chamber.	All Models
RH (Humidity)	90.0%	Note 1: A set point of 0 (zero) will put the system into an Idle state where it does not control and all alarms are inhibited. The sensor remains active and reports the level of gas/RH in the chamber.	NU-5820 and NU-5841
O ₂	21.0%	Note 2: A set point of 21.0% will put the system into an idle state where it does not control and all alarms are inhibited. Note 3: O ₂ set points below 10% will automatically reduce the Air Injection Time value to "0". This stops air injections that will interfere with achieving these lower O ₂ set points.	NU-5831 and NU-5841

- 8.8.1.4** Automatic Adjustment of Post Inject Delay Times when O₂ control system is active
Post inject delays are automatically adjusted according to the O₂ set point to facilitate gas and RH recovery after a door opening. The value displayed in the option menu will not change but is the basis for a formula in the software that calculates the new delay time depending on the O₂ set point. As the set point is reduced the delay times are shortened automatically through the software.
The value of the post inject delay time used is the value that shows in the Options display for that control system whether it is the default or user selected.
- 8.8.1.5** When the CO₂ system is active the level of CO₂ inversely affects the O₂ present in the chamber. The maximum achievable O₂ set point is indicated by the following table.

CO ₂ Set Point	Automatic maximum O ₂ Adjustment
0.1% to 1.0%	20.7%
1.1% to 3.0%	20.0%
3.1% to 6.0%	19.0%
6.1% to 10.0%	18.0%
10.1% to 15.0%	17.0%
15.1% to 20.0%	16.0%

8.9 Diagnostic and Checkout Procedures

The Incubator controller provides general diagnostic facilities:

- Diagnostic mode is intended for factory and field technicians.
- It allows them to turn the controller's output signals (heaters, valves, safety devices etc.) on and off.
- Diagnostics are located in the "Service Settings" menu categorized by the control systems (i.e. Temperature, CO₂, RH and O₂) plus a general category for diagnostics not directly related to the control systems. Press the "Diag" button to access them.
- Each screen and the function buttons in them initiate a 5-minute timer. When the timer runs out the display will exit that screen and go back to the main screen. Manually exiting the diagnostic screen will automatically stop that timer and return to the Service Settings screen. The function button that was activated will return the function to the default diagnostic condition at the end of the 5-minute timer. Manually putting the button back to the default condition will reset and stop the timer

8.9.1 Diagnostic Mode

To initiate the diagnostic mode, perform the following from the 'Main' screen:

- Select the NuAire Logo to enter "System Settings"
- Select "Service Settings" and enter 9876, and then hit enter (ENT)
- In the Service Settings menu, select the "Diagnostics" button for the desired function

Output/Input Diagnostic Parameter Functions

Temperature

1. Safety Relay (on/off)
2. Chamber Temp. Sensor (shows current temp.)
3. Safety Temp. Sensor (shows current temp.)
4. Chamber heater Triac control (**0 - 50%** - 100 %)
5. Door Heater Triac control (**0 - 50%** - 100 %)
6. Perimeter Heater Triac control (**0 - 50%** - 100 %)

CO₂

1. INACTIVE
2. CO₂ Sensor (Display current CO₂ percentage)
3. CO₂ Inject Valve /on/off
4. CO₂ Sensor bay Heater Triac (**0 - 50%** - 100 %)
5. CO₂ Sensor bay Temp. Sensor (Displays current temp.)

Relative Humidity

1. RH Sensor
2. RH Inject Solenoid valves
3. RH Water Temperature Sensor
4. RH Water Heater
5. RH Water Level Float Switch

O₂

1. O₂ Sensor (shows current oxygen level)
2. N₂ Inject Valve /on/off
3. O₂ Bypass valve on/off
4. Blocking Solenoid / on/off

General diagnostics

1. Power Supply Regulated +12 VDC (current voltage)
2. Power Supply Regulated -12 VDC (current voltage)
3. Air Inject Solenoid (on/off)
4. Alarm dry contact Relay (NO/C/NC) switch states
5. Air Pump Triac (on/off)
6. Spare AC Triac

(Note: Default values are in bold)

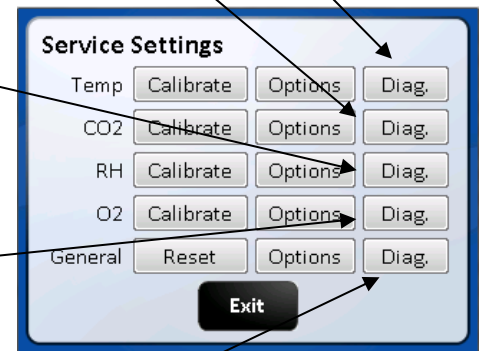

The paragraphs on the following page provide a more complete description of the diagnostics listed above.

The Diagnostic screen is shown to the right of each of the control systems Temperature, CO₂, RH & O₂ and the General category for your reference. Once entered, the Diagnostics screen will display the calibrated and uncalibrated values of the given function and all related components.

Temperature Control Diagnostics

1. Safety Relay

This function shows the current state of the safety relay. LCD display will show "On" or "Off" corresponding to the relay condition. On for closed or set or yes.

2. Chamber Temperature Sensor

This function shows on LCD the current values, calibrated (displayed) and not calibrated of the temperature sensor controlling the chamber temperature.

3. Safety Temperature Sensor

This function shows on LCD the current values, calibrated and not calibrated of the Safety temperature sensor located in the chamber.

4. Chamber Heater Triac Control (0%, 50%, and 100%)

This function allows the jacket heater to be turned on at different percentages 0, 50,100)

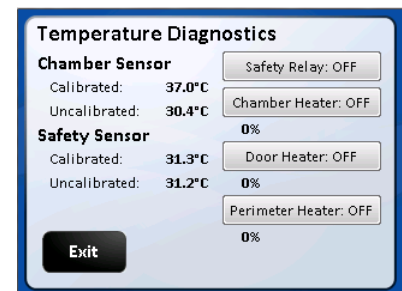

5. Door Heater

This function shows on LCD the current state of the door heater. This function also allows the door heater to be turned on at different percentages (0, 50, and 100 percent). The LCD display will show phase firing percentage chosen default is 0%.

6. Perimeter Heater

This function shows the current state of the perimeter heater. This function also allows the perimeter heater to be turned on at different percentages (0, 50, and 100 percent). The LCD display will indicate the percentage of phase firing chosen default is 0%.

CO₂ Control Diagnostics

1. CO₂ Sensor

This function shows the current CO₂ sensor reading both the “Un-Calibrated sensor signal and the Calibrated value shown in the display screen.

2. CO₂ Inject Valve / on/off

This function shows on LCD the current state of the CO₂ inject valve. LCD will show “ON” or “OFF” corresponding to the valve condition. On for open or set or yes.

3. Sensor Bay Heater Triac Condition / on/off

This function shows on LCD the current state of the sensor bay Heater triac. LCD will show 0, 50, and 100 percent corresponding to the relay position. The triac can be toggled to each percent of phase firing manually.

4. CO₂ Sensor Bay Temperature Sensor

This function shows on LCD the sensor bay temperature in degrees C. The Sensor bay is heated to temperature set point +3.5 degrees

5. Air inject Solenoid / on/off

This function shows on LCD the current state of the Air Inject Solenoid. LCD will show “ON” or “OFF” corresponding to the solenoid position. Default is off-solenoid activates when the button is touched

6. Air Pump / on/off

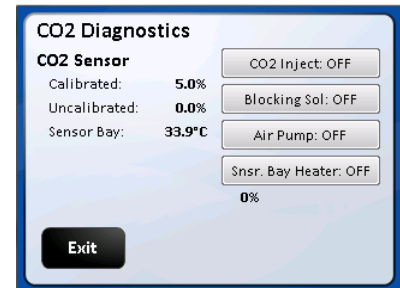

RH Control Diagnostics functioning

1. RH Sensor

This function displays the current value of the chambers RH sensor from 0 to 100%. It shows both the calibrated value shown in the display screen and un-calibrated sensor signal.

2. RH Inject Solenoid

This function indicates the on/off (default off) state of the RH Inject solenoid valve and allows the activation of it.

3. RH Water Level Float Switch

This function shows when the float switch is: Open=water level OK or Closed=water level Low.

4. RH Water Heater

This function reports back on whether the triac/heater circuit is on or off (default off) and allows the activation of it each time the RH heater button is pushed.

5. RH Water Temperature Sensor

This function shows the current temperature (in C) for the water in the water reservoir. The water temperature should be 10 deg. greater than the chamber temperature set point. It can reduce some during long RH injections after a door opening or when the system is first turned on but should recover within a few minutes.

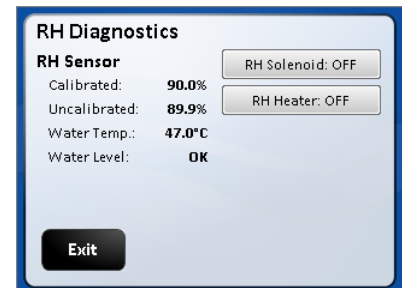

O₂ Control Diagnostics Functioning

1. O₂ Sensor

This value displays the current value of the chambers oxygen sensor both the Calibrated value shown in the display screen and Un-Calibrated sensor signal.

2. N₂ Inject Valve /on/off :

This function indicates the on/off (default off) state of the N₂ Inject solenoid valve and allows the activation of it.

3. O₂ Bypass valve on/off: THIS FEATURE IS NOT ACTIVE.

4. Blocking Solenoid /on/off

This function indicates the on/off (default off) state of the Blocking solenoid valve and allows the activation of it.

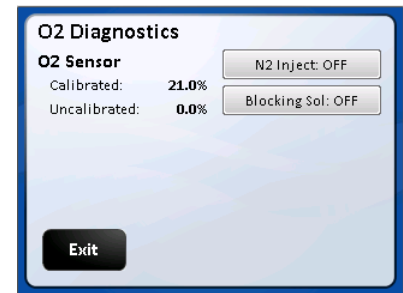

General Control Diagnostics

1. Power Supply Regulated +12 VDC

This function will display on the LCD screen the current value (+12.xx) of the regulated +12 VDC power supply.

2. Power Supply Regulated - 12 VDC

This function will display on the LCD screen the current value (-12xx) of the regulated -12VDC power supply.

3. Power Supply Regulated +5 VDC

This function will display on LCD screen the current value (+5.00) of the regulated +5 VDC power supply.

4. Chamber Air Inject Solenoid

This function shows on LCD the current state of the Air Inject Solenoid. LCD will show "ON" or "OFF" corresponding to the solenoid position.

Default is off-solenoid activates when the button is touched

5. Remote Alarm Relay

This function shows on LCD the current state of the remote alarm relay. The LCD display will show "ON" or "OFF" corresponding to the relay condition and its Normally Open (NO0 pair of contacts

6. Air Pump Triac

This function shows on LCD the current state of the Air Pump Triac. LCD will show "ON" or "OFF" corresponding to the relay position. The triac can be manually turned On and Off.

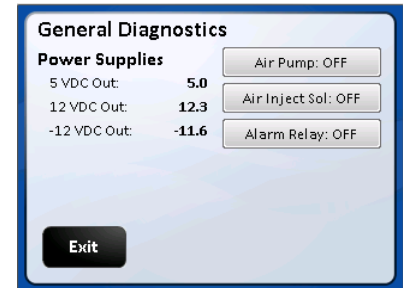

8.10 Option Configuration Parameters

Format: Option (**Default**, Minimum/Maximum)

All the options for the NU-5810 Incubator use this same format. The default is set at the factory and can be restored in the field with a Master or a Factory reset command. On the following pages, there is a short description of each Option with its Default/Minimum/Maximum setting, followed by a more detailed description.

Temperature

1. Maximum Above Set Point (**1.0°**, .1/10.0)
2. Temp Low Time Out Timer (**240 minutes**, 0/300)
3. Minimum Below Set Point (**0.5°**, .1/10.0)
4. Temp Sensor Differential (**4.0°**, 0/10.0)
5. Recovery Delay Time (**60 seconds**, 0/120)

CO₂

1. System Enable (**On**, On/Off) (in Settings Screen)
2. Maximum Above Set Point (**1.0%**, .1/10.0)
3. CO₂ Low Time Out Timer (**10 minutes**, 0/240)
4. Minimum Below Set Point (**0.5%**, .1/10.0)
5. Post Inject Delay Time (PIDT) (**60 seconds**, 0/250)

Relative Humidity

1. System enable (**On**, On/Off) (in Settings Screen)
2. Maximum above Set Point (**8.0 %**, 0.0/30.0)
3. RH Low Time Out timer (**60 minutes**, 0/300)
4. Minimum below Set Point (**3.0 %**, 0.1/15.0)
5. Post Inject Delay time (PIDT) (**90 seconds**, 0/300)

O₂

1. System Enable (**On**, On/Off) (in Settings Screen)
2. Maximum above Set Point (**1.0 %**, 0.0/10.0)
3. O₂ Time out timer (**30 minutes**, 0/300)
4. Minimum below Set Point (**1.0 %**, .1/10)
5. N₂ Post Inject Delay time (PIDT) (**30 seconds**, 0/300)

General

1. Door Close Delay Time (**60 seconds**, 0/300)
2. Air Inject Time (**10 seconds**, 0/100)
3. Air Inject Cycle Time (**1 minute**, 0/120)
4. Digital Output Interval (**0 minutes**, 0/120)
5. Door Ajar Alarm Delay (**5 minutes**, 1/60)
6. Settings (Text in top left side of screen)

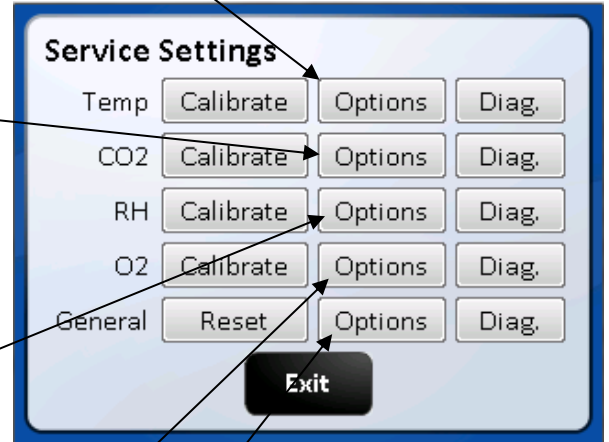

NOTE: Selecting any of the Option title texts will open a brief description of that option's functions. Default values are in bold.

The following paragraphs provide a more complete description of the Optional configuration parameters listed above.

Temperature

1. Maximum Above Set point

This value determines the maximum deviation, measured in (°C) that the chamber is permitted to rise above set point, once it is reached before an alarm condition is declared. An alarm condition will cause the chamber to enter a safe condition where no power is enabled to any of the system output controls until the situation is rectified.

2. Temp Time Out

This value determines the time, in minutes, for the temperature to achieve set point. If the temperature doesn't get to within 0.2° of set point within this time period, an alarm condition is declared.

3. Minimum Below Set point

This value determines the maximum deviation, measured in (°C) that the chamber is permitted to fall below set point, once it is reached before an alarm condition is declared.

4. Temp Sensor Differential

This value specifies a maximum differential, measured in temperature (°C) that the two temperature sensors may deviate from one another, or from the last read value. If this differential is exceeded, an alarm condition is declared. An alarm condition will cause the chamber to enter a safe condition where no power is enabled to the chamber heaters until the situation is rectified.

5. Recovery Delay Time

This value determines the time, in seconds, to turn off the chamber heaters in half-degree increments during a temperature recovery cycle. The delay time is required to prevent temperature overshoot of the control set point.

CO₂

1. CO₂ System Enable (Enabled/disabled) Is located in the bottom right of the screen

This function will enable or disable the CO₂ system. If the system is Enabled it will be displayed in the MAIN screen. If it is disabled it will not be displayed In the Main or the Option/Settings screen for the CO₂ system:

System Enabled (with check mark) means the System is enabled

System Enabled (without check mark) indicates that the system is disabled

2. Maximum Above Set point

This value determines the maximum deviation, measured in (%) that the chamber is permitted to rise above set-point, once it is reached before an alarm condition is declared.

3. CO₂ Time Out Timer

This value determines the time, in minutes, for the CO₂ percentage to achieve set point. If the CO₂ percentage doesn't get to within its lower limit of set point within this time period an alarm condition is declared. CO₂ injections are stopped, and air is injected for 15 minutes incase CO₂ was not being detected by the sensor. This alarm can be cleared through the alarm screens or by opening the inner door.

4. Minimum Below Set Point

This Function gives the ability to set the value in percent CO₂ below set point that starts the CO₂ time out timer described in item 2.

5. Post Inject Delay Time

This value specifies the time, in seconds, for an injection of CO₂ to be measurable at the sensor. When CO₂ is injected into the chamber, the system delays until this time period has elapsed before making a new control decision. In this manner, diffusion induced delays will not cause the CO₂ system to overshoot the control set point.

Relative Humidity

1. System Enable (Enabled/disabled) on models NU-5820 and NU-5841

(To Access this function: press Settings Text in Service Control Screen)

This function will enable or disable the RH system. If the system is Enabled it will be displayed in the MAIN screen. If it is disabled it will not be displayed in the Main or Option/Settings screen for the RH system:

System Enabled (with check mark) means the System is enabled

System Enabled (without check mark) indicates that the system is disabled

NOTE: System is disabled on all other models

2. Maximum above Set-Point

This value determines the amount, in percent, that the measured value can be above the set-point prior to setting an alarm condition.

3. RH Time Out Timer (Default 30 minutes)

This value determines the amount of time before declaring a RH Low alarm because RH level is not reaching Set-point.

4. RH Minimum below Set-Point (Default 3.0%)

This function gives the ability to set the value in percent RH below set-point that starts the "Not achieving set-point timer" described in item 2.

5. Post Inject Delay Time

This value specifies the time, in seconds, that the RH system delays control to allow detection of the level RH that was just injected into the chamber.

O₂

1. System Enable (Enabled/disabled) on models NU-5831 and NU-5841

(To Access this function press Settings Text in Service Control Screen)

This function will enable or disable the O₂ system. If the system is Enabled it will be displayed in the MAIN screen. If it is disabled it will not be displayed in the Main or the Option/Settings screen for the O₂ system:

System Enabled (with check mark) means the System is enabled

System Enabled (without check mark) indicates that the system is disabled

NOTE: System is disabled on all other models

2. Maximum Above Set-Point

This value determines the maximum deviation, measured in (%) that the chamber is permitted to rise above set-point, once it is reached before an alarm condition is declared.

3. O₂ Time Out Timer

This value determines the time, in minutes, for the O₂ percentage to achieve set-point. If the O₂ percentage doesn't get to within its upper limit of set-point within this time period an alarm condition is declared.

4. Minimum below set-point to Start Alarm Timer

This value determines the limit in percent that starts the Alarm Timer for declaring the alarm.

5. N₂ Post Inject Delay Time

This value specifies the time, in seconds, for an injection of N₂ to be measurable at the sensor. When N₂ is injected into the chamber, the system delays until this time period has elapsed before making a new control decision. In this manner, diffusion induced delays do not cause the O₂ system to overshoot the control set-point.

General Options

1. Door Close Delay Time

This value determines the time, in seconds, to increase the door and parameter heater to duty cycle by 10% after the inner door is closed. Also inhibits gas and RH control for the same period.

2. Air Inject Time

This value specifies the time, in seconds, for an injection of air into the chamber.

3. Air Inject Cycle Time

This value specifies the amount of time in minutes between each injection of air into the chamber.

4. Digital Output Interval

This parameter specifies the frequency, in minutes that performance and set point data is output to a device such as a printer that is only capable of receiving data. If the frequency is specified as zero, no data will be output.

5. Door Ajar Alarm Delay

Determines how long in minutes the glass door can be open before an alarm is declared.

6. Settings (text located at the top of screen)

Pressing the next button will go to the second page containing the following:

- The Filter Maintenance button to access:
 - Resetting the change filter notice
 - Setting time to reminder (**48 months**) and 0 disables the feature.
 - View time remaining until current notice is triggered.
- The Clear Password button that clears the 4 digit password that was input through the Set Password screen.
- Change language Button: Pressing this button brings up a screen with the language choices of English (default), Spanish, French & German. Pressing the button in that screen of the language desired will change the user screens to that language.
- Screen Lock button (default Main Screen Unlocked). Pressing this button will change it to "Main screen Locked" (Lockout = 1). This puts a "Press to unlock" button on the Nuair Logo in the Main screen. This feature stops accidental screen changes by brushing the touch screen. You must press and hold (2 seconds) until the message disappears which unlocks the main screen so that you can navigate into; the System settings, Alarms, Environmental Set Point and Clock Adjustment screens. Pressing the button again will change the text to "Main Screen Unlocked (Lockout = 0). This removes the "Press to Unlock" button from the Nuair Logo and the Main screen goes back to the default condition.

- Power Loss Mode cancel button. Cancels Power loss mode. Only use this if it is certain that there is no condensation in the circulation system. See Section 10.3 for further details about the Power Loss Mode.

8.11 Resetting the Electronics Software

8.11.1 Factory Reset

The Factory Reset is similar to the Mast Reset. However, it only changes the Options (returned to default settings) and the environmental set-points (returned to their defaults).

To perform a Factory Reset, you will need to do the following:

NuAire Logo → Service Settings → 9876 Enter → Reset → Factory Reset → Confirm

The Incubator will perform the Factory Reset and return to the Main screen.

8.11.2 Master Reset

The master reset diagnostic function is the last effort to correct operational faults which otherwise cannot be solved. By reloading the default configuration, the entire memory will be reset and ALL CALIBRATION OFFSETS, USER PASSWORD, CONFIGURATION OPTIONS, MODEL NUMBER OF THE INCUBATOR, AND THE SERIAL NUMBER WILL BE LOST. All calibrations will need to be performed following a master reset.

To perform a Master Reset, you will need to do the following:

NuAire Logo →
Service Settings →
9876 Enter →
Reset →
Master Reset →
Confirm

The Incubator will perform the Master Reset then the “Factory Setup” Screen will appear.

The Factory Setup screen shows the Model Number, Serial Number and Language that was chosen for the user screens.

As long as this information is correct you can press save which will save the information displayed in the screen then, take you to the date and time set screen. If the date and time are correct you can press exit and go to the MAIN screen. If you press Exit you will go to the main screen however if there is a power cycle the incubator will reboot to the Factory set up screen again. All setup information will show correctly but, you must press save to boot up into the MAIN screen after a power cycle. The model number and the serial number can be verified by comparing them to the serial number label found down behind the valence under the door. The language defaults to English. It can be changed any time through the Service Settings/General/Option/settings menu. See section 8.10 for further instructions.

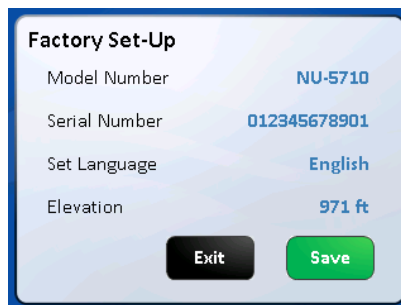

NOTE: After performing either Factory or Master Reset remember to turn the incubator off then on again to ensure that all intended parameters were reset.

8.11.3 Inputting the Factory settings:

The “Factory Set-up” screen will appear after the master reset. If the Model Number or the Serial Number need to be re-input for any reason the following steps should be taken:

Setting the model number sets the following function:

- Model number NU-5800 and NU-5810 D and E models
Enables Temperature and CO₂ the only control systems available on this model
Chooses the algorithm suited for low watt heating of the chamber
Supresses the Decon button in the “Systems Settings” screen
Loads the model number in the System information screen
- Model numbers NU-5820 through NU-5841 and D or E models
Enables Temperature and CO₂ plus RH and O₂ control systems as available on the various models
Chooses the algorithm suited for high watt heating of the chamber suited for heated Decon cycles.
Activates the heated Decon cycle choices in the “Systems Settings” screen
- Touch the “Model Number” text then follow the screen prompts as shown below.
Pressing continue on the choose Region screen will bring you back to the Factory Set-Up screen showing the Model Number you just entered.

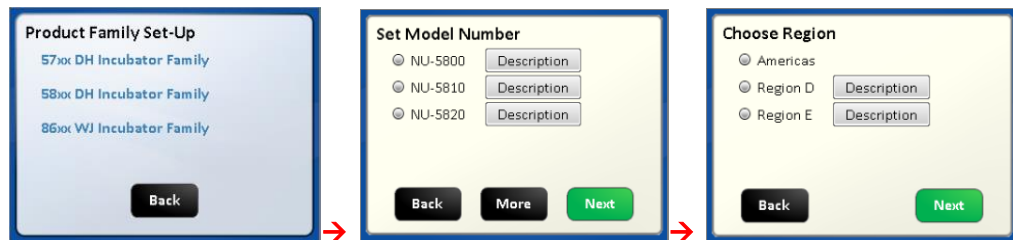

- Touch the Serial Number text then enter the 12 digits serial number which can be found on the serial number label located behind the valance under the sample port. Press the ENT button on the keypad screen and you will return to the Factory Set-Up screen showing the serial number you just entered. Default is blank if no number is entered.

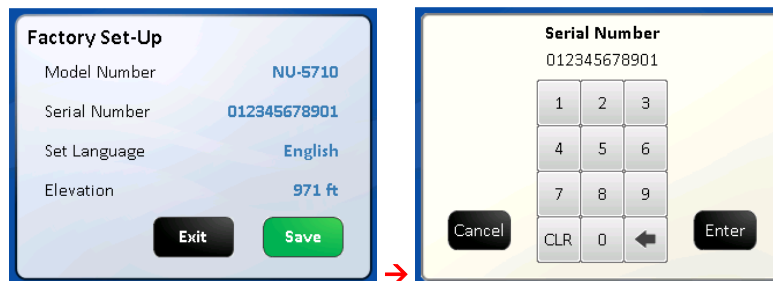

- Touch the Set Language text then touch the save button. This sets the language on all of the user screens. The language in the Service Settings menu /screen will remain in English. English is the default language if none is chosen. Touch the green save button to exit the factory screen.



- The final change that is requested is the clock. It should not have been reset. As long as the date and time are correct you can press cancel or save in that screen to exit to the Main screen.

- If the incubator loses power the date/time will flash in green text until it is manually interfaced with. If the date and time are correct you can cancel and the display will return to the main screen.
- When power to the incubator is lost long enough the real time clock will lose its backup power and the clock will revert to its default time. When power is restored to the incubator the date/time will flash in yellow text and continue until it is reset. Press save to return to the main screen and continue normal operation.

9.0 Calibration

Proper calibration of the incubator involves following parameters. On all models of the Invitrocell incubator the chamber temperature, door temperature, perimeter temperature, and CO₂ sensor require calibration at installation and the calibration should be checked on a regular schedule. The first three, chamber, door, and perimeter temperature should be completed and stabilized before any CO₂ sensor calibration is performed. On Invitrocell Below, each calibration procedure is described in detail. For the best results, follow the procedure carefully, and if the desired result is not achieved, try procedure again from the start.

9.1 Chamber Temperature Calibration

The DH's TEMPERATURE CALIBRATION MUST BE PERFORMED WITHIN 1°C OF THE PLANNED OPERATING TEMPERATURE. Normally, 37.0°C is the most common set point. To initiate the procedure, turn on the incubator via the power switch on the back panel. The default set point is 37.0°C; enter "Environmental Set Points" and adjust if desired. Let the unit stabilize for 8 to 12 hours. Use an independent calibrated instrument to check and calibrate the temperature.

Below is a description of calibration with a glass thermometer as one example for temperature calibration.

At the beginning of this procedure, set a calibrated glass thermometer in a glass beaker filled with water resting on a shelf in the middle of the chamber. Do not place the glass beaker on the bottom of the chamber because it will result in a slightly higher temperature reading due to the heater located on the chamber bottom. Placing the thermometer in glass beaker on the middle shelf will give the most accurate results for calibration. The chamber should be humidified to avoid false low readings due to evaporation of water from the flask. An accurate digital thermometer with a type K thermal couple could also be used. No matter what instrument is used the measurement for this calibration should be taken in the middle of the incubator chamber and in a stabilized condition.

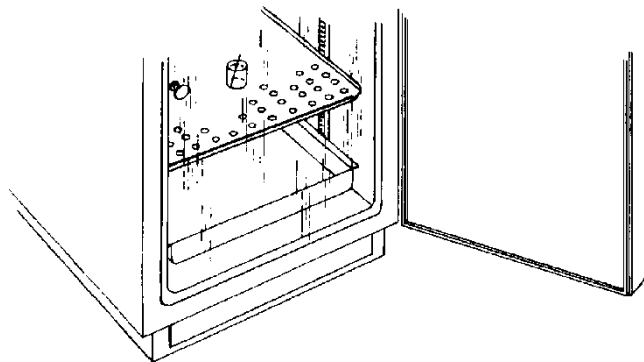

When the unit has stabilized at the operating temperature, perform the following calibration procedure.

- Allow Incubator to stabilize at its given temperature set point in run mode.
- Enter "Service Settings" by means of your provided password.
- Press the Temperature Calibration button.
- Determine actual temperature within chamber by reading temperature measurement instrument.
- Select the number digits below the "Current Calibrated Sensor Reading" blue text button
- Input the current value displayed on your temperature measurement instrument and exit calibration.

NOTE: THE DISPLAY DOES NOT UPDATE IMMEDIATELY; IT TAKES 2-3 SECONDS

The chamber temperature calibration is complete. Let unit stabilize for 8 to 12 hours. If the chamber temperature (actual thermometer) still does not match the display, perform the above procedure again. In some cases it might be necessary to calibrate several times to achieve a stable condition due to ambient conditions of temperature and humidity within the laboratory.

9.2 Door and Perimeter Duty Cycle adjustments for Temperature Calibration

The Door and Perimeter heaters are run on “Base Duty Cycle” calculations that are automatically increased or decreased to run in accordance with the chamber temperature at a chosen set point. These duty cycles work in the controlled lab environment but due to the many variables involved in temperature control there is also a manual adjustment. The heater duty cycles can be adjusted to control condensation or to improve the temperature uniformity in the chamber.

The inner glass door and outer shell perimeter temperature calibration is best accomplished by running the Incubator for a minimum of 24 hours with the water pan in place and perform the following calibration sequence, if required. Open the outer Incubator door and look for general condensation. Some condensation on the glass door can be desirable as an indication of adequate humidity in the chamber. Typically, one to two inches of condensation in the corners of the glass door and/or gasket indicates a properly calibrated door and perimeter heater. The perimeter heater is located on the outer shell next to the glass door gasket. If calibration is required, simply perform the procedure as stated below. As stated earlier the door and perimeter heaters operate on a base duty cycle calculated for the chamber temperature set point being used. In the door and perimeter heater (adjustment) screen “0.0” = the calculated base duty cycle. Adjusting the value up or down will increase or decrease the percent of power to each heater in 0.1% increments. Small adjustments are recommended to a maximum of 5.0% at a time.

The following steps should be taken for setting these duty cycle percentages:

- Allow Incubator to stabilize at its given temperature and humidity level in run mode.
- Enter the “Environmental Set Points” screen either from the MAIN SCREEN or the SYSTEM SETTINGS screen.
- Select the numerical digits following the “Door” or “Perimeter” text. Go to the adjustment screen.
- Press UP or DOWN keys to increase or decrease the numerical value to the desired level. The limits the settings can be changed to are +50 and – 20.
- Press “Done” to set current value and exit calibration.
- The reset button for both the door and the perimeter heaters resets the number displayed to 0.0 removing any adjustment previously made.

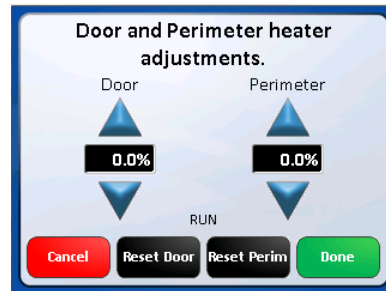
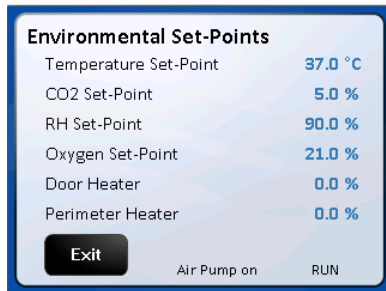

Adjusting Door and perimeter heater duty cycles to control condensation:

Location of condensation	Adjustment
On the inner glass door	Increase the door heater duty cycle in increments no greater than 5% at a time.
On the inner door gasket	Increase the perimeter heater duty cycle in increments no greater than 5% at a time.
In the back of the chamber	First decrease the door heater in increments of no greater than 5%. If condensation persists and condensation starts forming on the door then move to reducing the perimeter heater in the same manor until condensation stops form.

If condensation persists see section 9.3 Setting air injections.

9.3 Setting Air Injections

If there is still some undesired condensation in the chamber when the door and perimeter heaters are set for the desired result, the air injections can be adjusted. There is a control for length of the air injection labeled, Air Inject Time, and the frequency that air is injected called, Air Inject Cycle. These controls are described in more detail in the "General Options" section of the Service Settings menu. The default is 10-second injections every 1 minute. Start by increasing the length of

the injection by a few seconds at a time then increase the frequency if needed. If the humidity in the chamber is less than desired, reduce the Air Inject Time.

Air and O₂ Levels

When the O₂ set point is set below 10% the “air inj time” is automatically reduced to 0(zero) to stop air injections which will interfere with achieving the lower O₂ set points.

9.4 CO₂ Calibration

The DH infrared CO₂ sensor may be calibrated using the following technique: Open Door Zero-Span Calibration. CO₂ calibrations can be performed in approximately two minutes, by accessing the CO₂ calibrations menu in “Service Settings” and follow the -screen instructions. To perform the Open-Door CO₂ sensor calibration routine, perform the following:

- Attach independent CO₂ monitoring device to the sample port in the center of the inner glass door of the unit.
- Enter CO₂ calibrations by means of Service Settings.
- Select the “Open Door Zero Span Calibration” text.
- Follow on-screen instructions.

NOTE: The CO₂ sensor has an internal SPAN limit of +/- 8% of the displayed value (i.e. display value is 5%, change up to 5.4% would be accepted by the system). It is always recommended NOT to enter the full measured value into the SPAN when calibrating. This will avoid overshoot and stay on the lower side of the internal CO₂ sensor value tolerance (rounding and significant values). If the CO₂ sensor rejects the SPAN value, either try again or lower the value.

9.4.1 CO₂ Off Set Calibration

CO₂ Off Set Calibration can be performed anytime an independent measurement doesn't correlate to the front panel display. However, this calibration SHOULD NOT BE PERFORMED MORE THAN ONCE PER WEEK. Sensor calibration should be performed if an independent measurement doesn't match the display within ±0.3 percent within one week after a sensor calibration. Before doing the following calibration, check and change, if necessary, the Incubator in-line filter found within the Sensor Bay.

When unit has stabilized at the operational temperature and CO₂ percentage, take an independent measurement and, if necessary, perform the following:

- In “Service Settings” enter the CO₂ Calibrations menu.
- Press the “CO₂ Offset Calibration” text button.
- Use an independent instrument to determine actual CO₂ percentage (compare the display CO₂ to the independent measurement). If these two readings have a difference equal to or less than 0.5 percent, proceed to enter the CO₂ Fyrite value. This calibration only allows a maximum of 0.5% offset. (See * **Note** below) If the difference is greater than 0.5 percent, it is recommended to perform a CO₂ Open Door Calibration.
- Enter the value measured by the independent device.
- Exit and Save to retain this value.

***NOTE:** When the display value is more that 0.3% different from the measured value, offset display 1/2 the difference measured. Allow the Incubator to stabilize back to set point, then measure the CO₂ in the chamber again. Offset the display again if necessary.

9.4.2 Closed Door CO₂ Sensor Calibration Routine

- Attach independent CO₂ monitoring device to the sample port in the center of the inner glass door.
- Enter CO₂ calibrations by means of Service Settings.
- Select the “CO₂ Closed Door Zero Span” text.
- Follow on-screen instructions.

Enter measurement on independent device when prompted.

Allow the unit to run and stabilize for a minimum of 2 hours then, check calibration with an independent instrument. Compare the display CO₂ percent to your independent measurement. If these two readings have a difference greater than 0.3%, repeat the above procedure. If these two readings have a difference of less than 0.3%, perform the CO₂ Offset calibration procedure in Section 9.4.1.

9.4.3 Elevation

This setting specifies the elevation. It is used to calculate pressure compensation for the CO2 sensor. The unit of measure is in feet. The elevation of your area can be entered.

This function is in the service settings – 9876 – Options – Next – Elevation. The elevation can be entered by touching the keypad's current elevation (default is 971 ft) and entering your current elevation. **(Min 0 – Max 30000)**

This will calculate the pressure compensation for the CO2 sensor and provide a more accurate CO2 measurement.

9.5 Relative Humidity sensor calibration - System available on Models NU-5820 and NU-5841

Relative humidity calibration can be performed anytime if the relative humidity system has been installed. The relative humidity sensor can be calibrated from a known source of humidity within the Incubator chamber. Typically, the water pan is used because it has a known minimum humidity level of 96 percent after 12 hours. A hygrometer can also be used to calibrate the chamber Relative Humidity. See the following instructions for both methods of calibration.

9.5.1 Calibrating with a water pan (included with the Incubator)

As stated in the introduction the relative humidity sensor can be calibrated from a known source of humidity within the Incubator chamber. Typically, the water pan is used because it has a known minimum humidity level of 96 percent after 12 hours **when the Air injections are deactivated**. This calibration is done with the O₂ set point at 21% to disable N₂ injections during the procedure.

To use the water pan

- Access the Environmental Set points screen to set the RH set point to zero if not set there already.
- Go to the Service Settings/General/Options button and change the Air Inject time from 10 (sec) to 0 (sec). This will stop air injections which is necessary to reach RH saturation of the chamber.
- After 12 hours refer to 9.5.3 Display Offset Calibration section for instructions on how to adjust the display displayed value for RH.
- Set the calibration to 96% RH
- Remember to reset the air inject time to 10(sec.) after you complete the calibration and choose your RH set point above zero.

NOTE: Some condensation can be expected in the chamber at this humidity level with the air injections turned off.

9.5.2 Calibrating with a Hygrometer

When unit chamber has stabilized at the operational temperature, CO₂%, the RH set point has been chosen and with water in the tank the heater has been powered for at least 60 minutes ensuring it is up to temperature. Allow the RH system to achieve set point and stabilize there for at least 30 minutes. Then a measurement with an independent hygrometer probe can be made. It is usually inserted into the chamber through the chamber access port located on the right side of the incubator. The Hygrometer must be up left undisturbed until it indicates that it is up to the chamber temperature or until the temperature on the hygrometer stops increasing for at least 5 minutes. Take a reading then move to the Display Offset Calibration described in the next section to adjust the RH value for the incubator system.

ACCURACY OF CALIBRATION W/ THE HYGROMETER:

The hygrometer used to calibrate the Incubator sensor will have a tolerance that is specified by the manufacturer of the instrument. The tolerance of accurate hygrometers can be as tight as $\pm 2\%$ others can have tolerances of $\pm 3\%$ or greater at this humidity level. This means that when 90% is read on the instrument the actual relative humidity percentage can be at the high or low limit of the hygrometer's tolerance. If condensation is encountered the value that the incubator displays can be adjusted accordingly.

9.5.3 Display Offset Calibration:

Pressing the Calibrate button on the Service settings screen produces the Calibrate the RH offset screen as show to the right. Press the Calibrated sensor reading value (blue text) to access the keypad screen then, to input the independently measured value and press the ENT button on the keypad. This returns you to the “Calibrate RH offset” screen. I might take a couple of seconds for the new value to appear in this screen. Then, press the **SAVE** button to return to the “Service settings screen”. Pressing the exit button in that screen will return you to the MAIN screen.

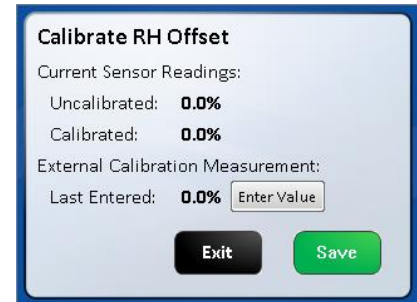

NOTE:

1. **When you use the Water pan method of calibration remember to set the “Air Inject Time” back to 10 (sec). Otherwise Condensation is likely to form in the chamber. That Option is accessed through Service settings/General/Options button.**
2. **Choose the desired set-point that you want to run the system at in the “Environmental Set Point screen remembering that it was set to 0 (zero) for the calibration.**

9.6 O₂ Calibration – System available on Models NU-5831 and NU-5841

When unit chamber has stabilized at the operational temperature, CO₂%, and RH%, O₂ system has been powered for at least 10 minutes ensuring the sensor is up to temperature - take an O₂ measurement with an independent instrument through the chamber sample port used for taking CO₂ readings. It is located behind the cover under the incubator outer door and, if necessary, perform the following:

NOTE: If a Fyrite instrument is used,

BE SURE TO READ THE O₂ FYRITE OPERATING AND SAFETY INSTRUCTIONS FOR PROPER O₂ MEASUREMENTS AND SAFETY CONSIDERATIONS.

Display Offset Calibration:

Press the Calibrate button on the Service settings screen produces the Calibrate the O₂ offset screen. Press the Calibrated sensor reading value to access the key pad to input the independently measured value then press the ENT button on the key pad. When you return the Calibrate O₂ offset screen press the save button to return to the System settings screen. Press the exit button in this screen to go back to the main screen.

10.0 Maintaining Your DHD

DHD Chamber

The chamber maintenance is up to the discretion of the owner and the extent of cleanliness and sterility desired. The shelves and bracket supports are all removable and autoclavable. The interior should be wiped down with an appropriate disinfectant such as 70% ISOPROPYL ALCOHOL or equivalent.

NOTE: DO NOT USE ANY CHLORINATED OR HALOGEN MATERIALS IN THE CHAMBER. SUCH MATERIAL IS HARMFUL TO THE POLISHED STAINLESS STEEL.

NOTE: NuAire does not offer any product warranty with respect to cleaning material compatibility. USE AT YOUR OWN RISK! The information provided above is from raw material suppliers and known general source documents for use to develop application cleaning SOP's.

The humidity pan should also be sterilized and the water changed regularly to assure sterility. A small amount of copper sulfate may be added to the humidity pan to inhibit bacterial growth.

CO₂ / N₂ Supply Filter

P/N X-980385 (50 mm Disk, Uni-directional In-Line, Dry)*

The CO₂ / N₂ Supply Filter should be replaced every fifth empty CO₂ tank or when the filter is visibly discolored (yellow-brown).

NOTE: Direction of flow (IN is labeled on one side of filter) when replacing filter.

Sensor Bay Capsule Filter

P/N RF566 (Capsule, Uni-Directional In-Line, Wet)

This filter should be replaced EVERY FOUR YEARS to assure optimum performance.

A visual check should be performed when maintenance reminder appears in the main screen to assure filter integrity.

Remove sensor bay cover to perform a visual check.

Air Supply Filter

P/N X-980385 (50 mm Disk, Uni-directional In-Line, Dry)*

The Air Supply Filter should be replaced every fifth empty CO₂ tank or when the filter is visibly discolored (yellow-brown).

NOTE: Direction of flow (IN is labeled on one side of filter) when replacing filter.

CO₂ Sensor Filter

P/N X-980366 (50mm Disk, Uni-Directional In-Line, Wet)*

The filter should be changed when discolored (yellow-brown).

The filter is plumbed in the chamber sample hose and can be inspected when the cover is removed to check the air pump filter.

This filter has a green dot to distinguish it from the "dry" filter.

*** NOTE: The word "In" on the outer rink of the body indicates the inlet side of the filter and should be installed toward the gas supply.**

10.1 Heated Decon Cycles

Heated Decontamination Cycle Preparation and use Procedures for Incubator models:
NU-5810, NU-5820, NU-5831 and NU-5841

IMPORTANT
READ AND UNDERSTAND ALL OF THE ATTACHED INSTRUCTIONS BEFORE USING
THE HEATED DECONTAMINATION CYCLES

NuAire gives the lab professional the choice of the 2 most commonly accepted, heated decontamination cycles available. They are a 95°C humidified cycle and a 145°C dry cycle. To choose, the user goes to the System Settings menu and pushes the Decon button in the lower right hand of the display. From there it will ask which Decon (95 or 145), and proceed to instruct the user in preparation of the chamber.

Choosing the 145° DECON CYCLE

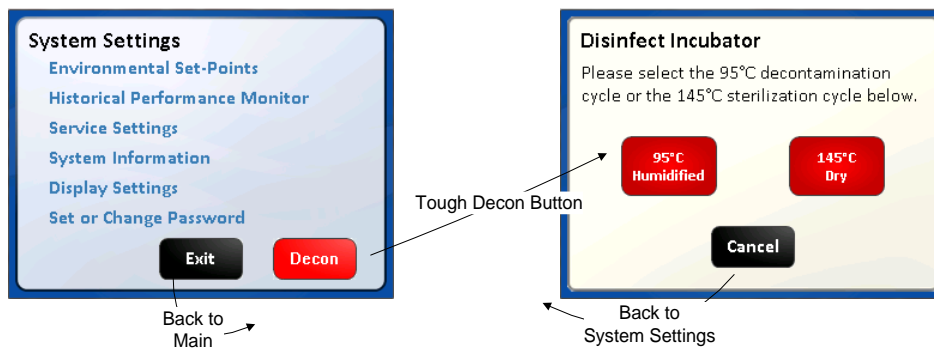

The 145°C decontamination cycle is high temperature dry cycle to ensure that the contaminating agents are eradicated. The complete cycle takes less than 8 hours to run. (See graph for cycle phases). There is no need to recalibrate or remove the CO₂ IR sensor since it is not located in the chamber. See the instructions above for choosing this cycle in the System Settings Menu.



OUTER DOOR MUST REMAIN CLOSED DURING THE DECONTAMINATION CYCLE OR IF CHAMBER TEMPERATURE IS OVER 55°.



THE DECONTAMINATION CYCLE WILL HEAT THE INCUBATOR INTERIOR SURFACES TO 145° C +. CONTACT WITH ANY SURFACE INSIDE OF THE OUTER DOOR DURING THIS CYCLE CAN RESULT IN BURNS.

PREPARATION

Following the prompts in the incubator display screen you will:

- Remove culture cells, samples, dishes, instruments, or other user-introduced equipment from the chamber.
- Wiping out all spills and materials from chamber walls, shelves, plenums, & inner door may be required to avoid stains, odor and material baked on these surfaces during the cycle.
- If a cleaner is used make sure it is compatible with the construction of the chamber (stainless steel).
- Ensure the hole in the access port plug at the side of the Incubator is open.
This is a relief for the chamber during the Decon Cycle.
- Models NU-5820 and NU-5841 remove the RH sensor from upper left side of the back wall of the chamber. The sensor will be damaged if it is not removed. The sensor cable is made to withstand the heat of a Decon cycle and is left in place.



FOLLOW ALL FEDERAL, STATE AND LOCAL REGULATIONS THAT APPLY WHEN USING CLEANER. ANY RESIDUE LEFT OF THE CLEANER WILL BE EXPOSED TO THE DECON. TEMPERATURES CHECK WITH MANUFACTURER ABOUT EXPOSURE OF THE CLEANER TO THESE TEMPERATURES.

DRY 145° C DECON CYCLE

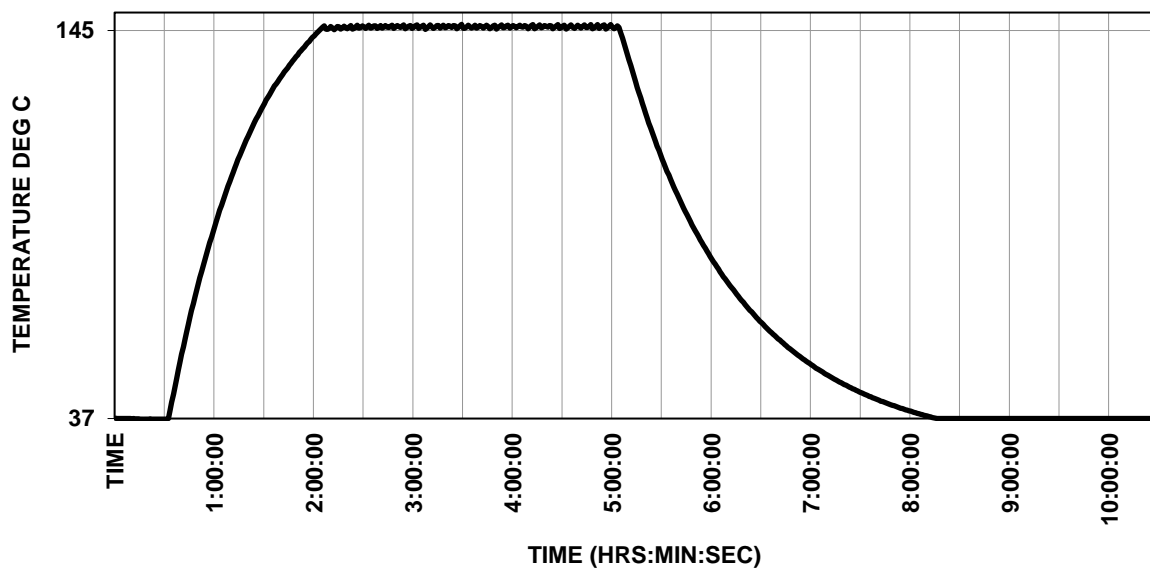

NOTE:

- CO₂, RH and O₂ control systems will be idle during the cycle.
- Protection of the CO₂ and O₂ sensors during the heated cycle is automatic.
- RH sensor must be removed from all models equipped with RH control the as stated in the Preparation section and in the NuTouch screen prompts that show during the startup of the cycle. The sensor will be damaged if it is not removed.
- The Decon Cycle will not advance to the heat up phase unless the door is opened.
- Follow the on screen instructions, pressing the Next button when each step is completed

Start the Decon cycle by following the prompts on the NuTouch display screen.

The Decon cycle will automatically go through the following phases:

HEAT UP 2 hours on average

- Complete the chamber preparation and either schedule a start time or press the Start button to start the heat up portion of the cycle.
- Temperature display shows chamber temperature.
- Text displays that the unit is currently in the Heating Up cycle
- A timer tracks how long the unit has been heating thus far

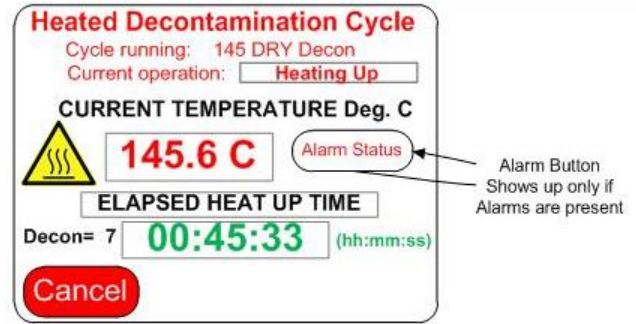

DECONTAMINATION 3 hours

- The unit automatically starts a countdown timer for the correct length of cycle when the decontamination temperature is reached.
- Temperature display shows chamber temperature.
- Text displays that the unit is currently in the Decontamination cycle.

COOL DOWN & STABILIZING 4 hours

- When the decontamination period is complete the heaters are shut off and the air pump is turned on blowing HEPA filtered air to cool the chamber to the user chosen temperature set point.
- Temperature display shows chamber temperature during cycle.
- Text displays that the unit is currently in the Cooling Down portion of the DECON cycle
- A count up timer (incrementing time) tracks how long the unit has been cooling down

CYCLE COMPLETE

- Indicates the user should:
 - Refill the water pan with single distilled water no purer than 1 Mega OHM in preparation to return to normal running.

NOTE: If Decon Cycle is run as routine maintenance, it is ok to reuse the HEPA filters for the service life indicated in Section 10.

If contamination is an issue due to the room environment, HEPA filters can be replaced as necessary.

RESUME NORMAL OPERATION

- Press the Exit button after fulfilling the on screen instructions
 - This puts the Incubator into normal run mode
 - CO₂ control resumes
 - Checking the calibration of the temperature sensor is recommended. Follow the instructions in section 9.1 of the manual

DECON CYCLE NOTES:

- Aborting the cycle:
To abort any phase of either the 95 or 145 decontamination cycles press the cancel button to step through the different phases of the cycle that are described above. The cool down phase cannot be bypassed until temperature reduces to the temperature set point. See cautions below.
- In case of a power interruption, the heat up, drying & cool down phases will resume when power is restored. The Decon phase will reset to the beginning of the 3-hour cycle or if the temperature drops more than 10° it will go back to the heat up phase then resume the cycle when Decon temperature is reached.
- It is considered normal for some odor to occur during the Decon Cycles. This odor reduces with use of the Decon Cycle.
- Some discoloration due to heat of the chamber and its components can be expected.
- If Decon temperature is not reached within the time allotted (set by the temp. Time Out option). The Incubator will alarm and indicate an Alarm Status condition in the display.

- If the inner glass door is opened during the Decon Cycle an alarm sounds and the Decon Door Open Alarm will overtake the display telling the user to close the door.
- Place Incubators 10" apart when placed side-by-side to enable running the heated Decon Cycle while surrounding Incubators are in normal run mode.

USING THE 95° DECON CYCLE

The 95° C decontamination cycle is humidified to ensure that the contaminating agents are eradicated. The complete cycle takes about 14 hours to run. (See graph for cycle phases). There is no need to recalibrate or remove the CO₂ IR sensor since it is remote from the chamber.



OUTER DOOR MUST REMAIN CLOSED DURING THE DECONTAMINATION CYCLE OR IF TEMPERATURE IS OVER 55°.



THE DECONTAMINATION CYCLE WILL HEAT THE INCUBATOR INTERIOR SURFACES TO 95° C +. CONTACT WITH ANY SURFACE INSIDE OF THE OUTER DOOR DURING THIS CYCLE CAN RESULT IN BURNS.

PREPARATION

Following the prompts in the incubator display screen you will:

- Remove culture cells, samples, dishes, instruments, or other user-introduced equipment from the chamber.
- Wipe out all spills and materials from chamber walls, shelves, and plenums using a disinfectant of choice that is compatible with construction of the Incubator chamber and instrumentation.
- Ensure the hole in the access port plug at the side of the Incubator is open. This is a relief for the chamber during the Decon Cycle.
- Ensure that the sample port in the front panel of the Incubator is capped. Condensation can form in tubing if it is left open.
- Models NU-5820 and NU-5841 remove the RH sensor from upper left side of the back wall of the chamber. The sensor will be damaged if it is not removed. The sensor cable is made to withstand the heat of a Decon cycle and is left in place.
- Empty water pan then clean it with a disinfectant then, fill with 300ml of water. Place it back in the chamber on the highest shelf for the Decon cycle.



FOLLOW ALL FEDERAL, STATE AND LOCAL REGULATIONS THAT APPLY TO THE DISINFECTANT USED TO CLEAN THE CHAMBER.

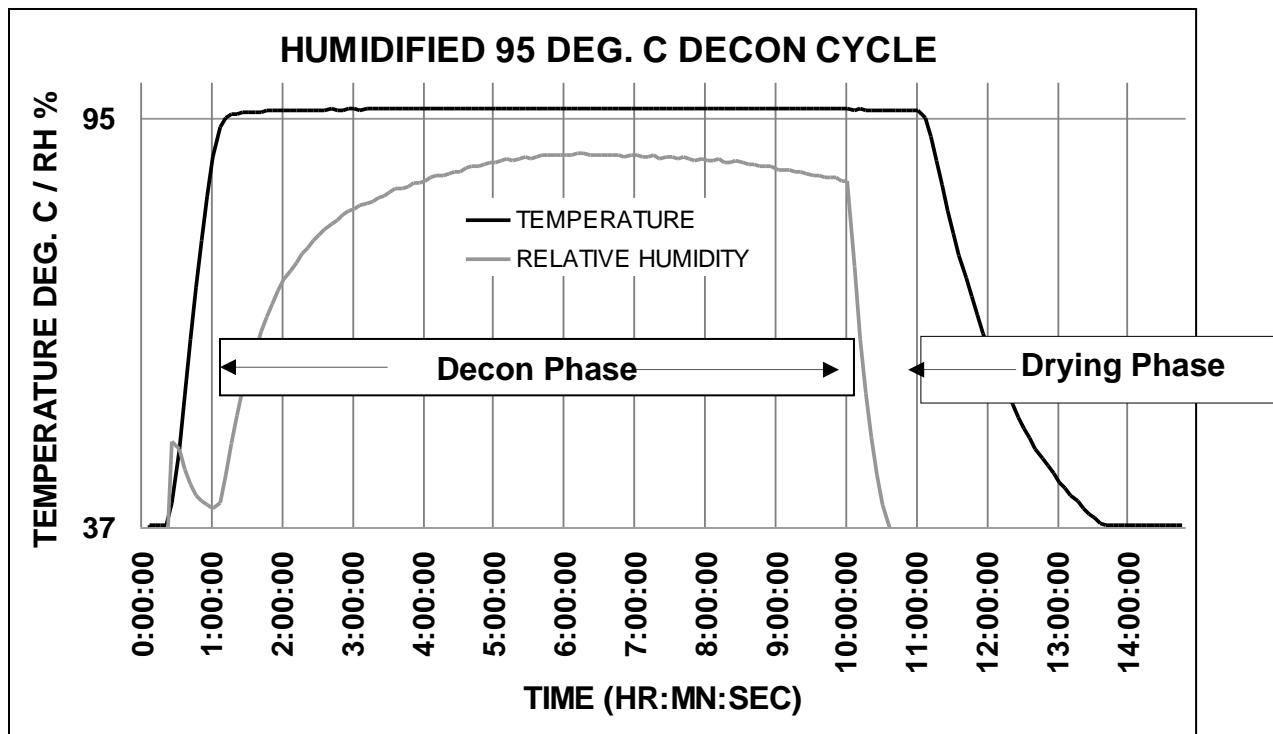

NOTE:

- CO₂, RH and O₂ systems will be idle during the cycle.
- Protection of the CO₂ and O₂ sensors during the heated cycle is automatic.
- RH sensor must be removed from all models equipped with RH control the as stated in the Preparation section and in the NuTouch screen prompts that show during the startup of the cycle. The sensor will be damaged if it is not removed.
- The Decon Cycle will not advance to the heat up phase unless the door is opened so that the NuTouch screen prompts to empty the water pan, clean the chamber and remove the RH sensor are followed.
- Follow the on screen instructions, pressing the Next button when each step is completed

Start the Decon cycle by following the prompts on the NuTouch display screen.

The Decon cycle will automatically go through the following phases:

HEAT UP 1 hour

- Complete the chamber preparation and either schedule a start time or press the Start button to start the heat up portion of the cycle.
 - Temperature display shows chamber temperature.
 - Text displays that the unit is currently in the Heating Up cycle
 - A timer tracks how long the unit has been heating thus far

DECONTAMINATION 9 hours

- The unit automatically starts a timer for the correct length of cycle when the decontamination temperature is reached.
 - Temperature display shows chamber temperature.
 - The Text displays that the Decontamination cycle is in progress
 - A timer tracks the remaining time in Decontamination

HUMIDITY REDUCTION 1 hour

- The unit remains at the decontamination temperature and the air pump is turned on to reduce the humidity left from the decontamination phase.
 - Temperature display shows chamber temperature during cycle.
 - The Text displays that the Decontamination cycle is in progress
 - A timer tracks the remaining time in Decontamination.

COOL DOWN 3 hours

- When the humidity reduction period is complete the heaters are shut off to cool the chamber to the user chosen temperature set point.
- Temperature display shows chamber temperature during cycle.
- The Text displays that the unit is now in the Cooling Down cycle
- A timer tracks how long the unit has been cooling

CYCLE COMPLETE

- Indicates the user should:
 - Refill the water pan with single distilled water no purer than 1 Mega OHM in preparation to return to normal running.

NOTE: If Decon Cycle is run as routine maintenance, it is ok to reuse the HEPA filters for the service life indicated in Section 10. If contamination is an issue due to the room environment, HEPA filters can be replaced as necessary.

RESUME NORMAL OPERATION

- Press the Exit button after fulfilling the on screen instructions.
- This puts the Incubator into normal run mode
- CO₂ control resumes
- Checking the calibration of the temperature sensor is recommended.
- Follow the instructions in section 9.1 of the manual

10.2 Chemical Decontamination of the Incubator Chamber

To chemically decontaminate NuAire Incubator inner chambers, users may use the traditional formaldehyde or Chlorine Dioxide in gas form, or Vapor Phased Hydrogen Peroxide. All three of the chemicals are compatible to all parts within NuAire Incubator chambers. The incubator should be turned off during these procedures

NOTE: As stated previously, the chamber and components can also be wiped down with a 70% solution of Isopropyl Alcohol for cleaning and decontamination.

10.3 Power Loss Recovery Mode

When an incubator experiences a sudden loss of power there is an increased chance of condensation building up in the circulation system tubing. This mode helps to dissipate that buildup before it causes the sensors to fail

- Conditions for entering mode: - Incubator must be without power for 45 minutes or longer. This includes first time setup. Mode is automatically triggered after power is restored (after 45+ min outage). If less than 45 minutes have passed incubator will enter normal Run mode.
- When in Power Loss Recovery Mode:
 - Blocking solenoid will be turned "ON" which will bypass the CO₂ and O₂ sensors in the circulation system.
 - Both systems will be put in standby mode meaning they will not control or alarm while in this mode.
 - "Power Loss Recovery" shows in place of "RUN" in the main screen.
 - Heaters and Air Pump run as normal.
- Once entered, this mode will run for 1 hour. A count down timer screen (see below) can be found when pressing the CO₂ or O₂ Diagnostics button in the Service Settings screen. It is also recorded in the event log.

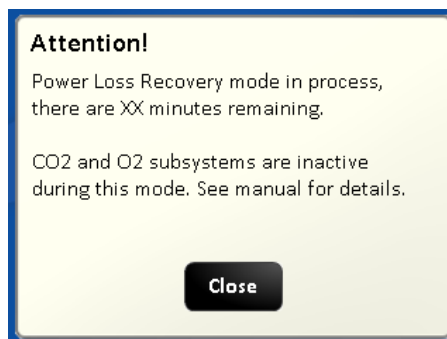

10.4 Shutting down the Incubator

Prior to shutting down the Incubator open the inner and outer doors and remove the water pan. Leave doors open for at least 5 minutes prior to shutting it off. This will purge the chamber, circulating system and the sensors of humidity that could condense and cause faulty readings when the Incubator is turned back on. Be sure to empty the water pan prior to putting it back into the chamber if the Incubator is going to be shut off for any length of time.

10.5 Automatic Filter Change Notification

The Capsule filter located in the Sensor Bay (see BCD-18319 for location) should be checked on average every 2 years to see if it should be changed. The Filter material is normally a white material. Discoloration of the filter material is an indicator that it should be changed. Retro Fit Kit RF566 should be ordered for the replacement filter. A timed notice triggers a Maintenance Notification button in the Main Screen when this timer counts down to zero. Pressing the Maintenance Required button produces a screen indicating that the timer for filter life has expired.

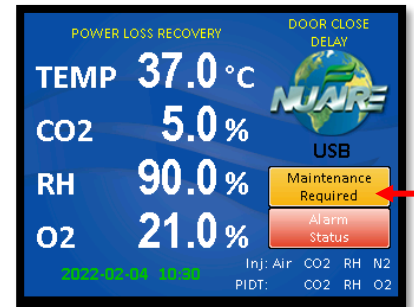

Responding to the notification:

From the main screen press the NuAire Logo / Service settings / General Option / Next / Filter Maintenance to access the Filter Maintenance screen.

In these screens you can:

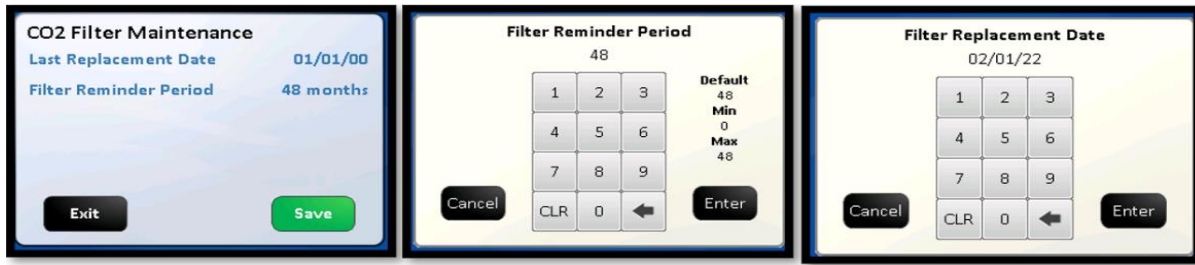

- Extend the alarm by 1 month by pushing the Last Replacement Date, date displays, extend the date by one month. Press the Enter, Save, and Exit button to retain the extension and go to the General Settings screen. Pressing Save will not retain the time extension.
- Reset the notification by pressing Last Replacement Date and extending the date by one month.
- Press the Save button to save the timer setting and go the General Setting screen. Pressing the Exit button will not save the new timer setting.
- Setting the timer to 0 months deactivates the notification.

After extending or resetting the timer you can return to the main screen by following the screen prompts to save your choice and exit the menu.

11.0 Error Indicators & Troubleshooting

Step 1 NOTE ALL ERROR INDICATORS

When the Incubator is running, the Alarm Status button indicates an error.

Pressing the Alarm Status button, entering the correlating Alarms Menu and pressing the Silence button in the Alarms Menu will silence the audible alarm until Diagnostics is entered or another alarm becomes active.

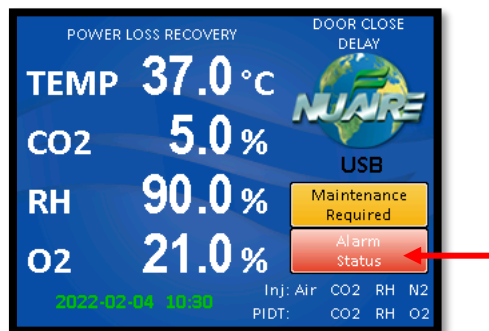

Step 2 CLEAR ERROR INDICATORS.

Error indicators can be cleared by pressing the Alarm Status button and entering the Alarms Menu and pressing the Clear All button; if the error is still present the indicator will return when the alarm time reaches 0.

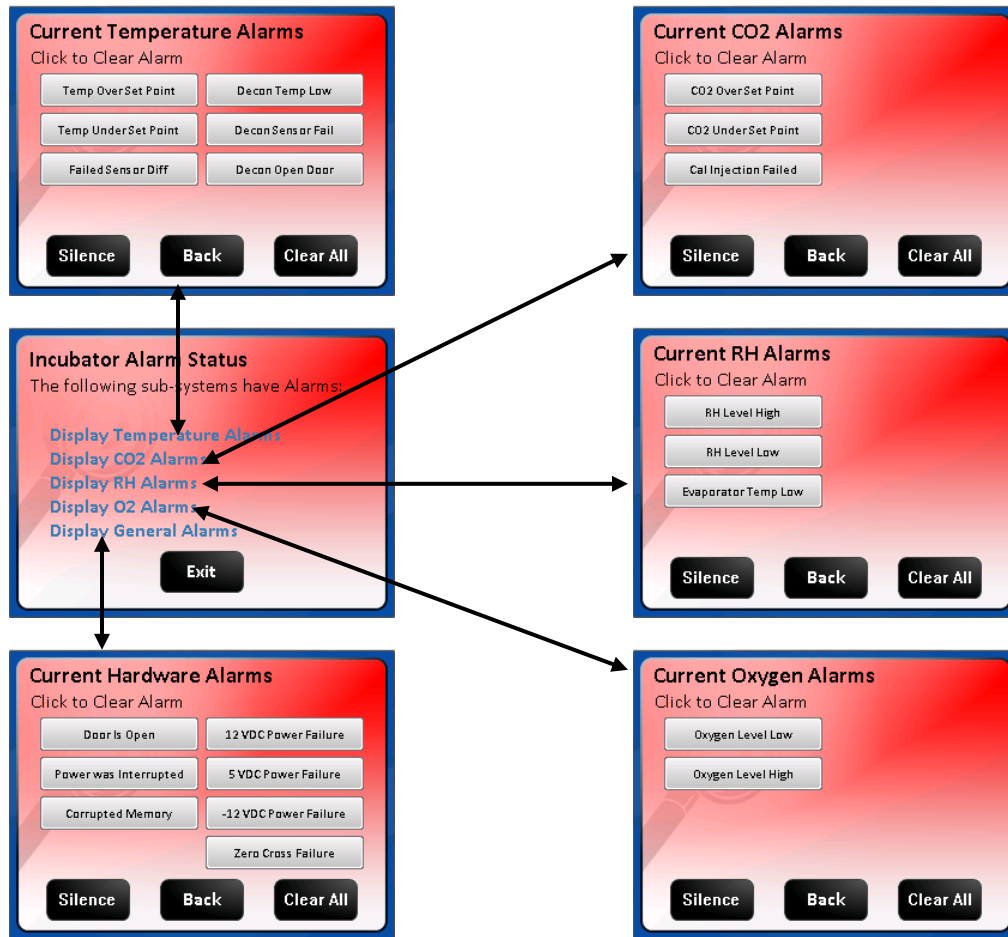

Step 3 MONITOR REOCCURRENCE OF ERROR INDICATORS.

If recurrence of the error indicator is immediate or daily, use the Error Indicator Troubleshooting Guide on the following pages to address the issue indicated by the reoccurring alarm.

Error Indicator Troubleshooting Guide

Temperature System		
Displayed Error Code	Code Description	Checks and Corrections
Temp Over Set Point, Decon Temp High	-Temperature over set point Normal mode and Decon Cycle	Check temperature sensor calibration. Faulty TRIAC, replace control board.
Temp Under Set Point, Decon Temp Low	-Temperature time out error during normal running and in Decon Cycle - Decon Time Out - Temp less than Decon temp -4° for 240 minutes	Check temperature sensor calibration Replace fuse. Faulty TRIAC, replace control board Faulty chamber heater contact NuAire Technical Service. Door/Perimeter heater needs to be increased with a high temperature set-point in a low ambient temperature
Failed Sensor Differential	-Sensor temperature (differential) error normal running. -Occurs when difference between sensors exceeds 4°C.	Check temperature sensor calibration Check connection on control board One or both temp sensors faulty, replace

Decon Sensor Fail	-Sensor temperature (differential) error Decon Cycle. -Occurs when difference between sensors exceeds 10° C.	Check temperature sensor calibration Check connection on control board One or both temp sensors faulty, replace
Maintenance Required	Breakdown in communication	Both temp. sensors disconnected, check the connection of temp. sensors between main and display boards

CO₂ Sensor Bay Heater		
Displayed Error Code	Code Description	Checks and Corrections
Temp Sensor Failure	-Defective temperature sensor	Confirm it is plugged in at board connector P6. Replace CO ₂ bay temperature sensor
Sensor Bay Temp Low	Sensor bay is below temp set point +2° - See CO ₂ diagnostics screen	Check control board output to relay, replace board if faulty. Check that all connections are secure Check sensor bay heater for function, replace if faulty.
Sensor Bay Temp High	Sensor bay temp is above 65 deg C	Check control board output to relay, replace board if faulty. Check that all connections are secure Check sensor bay heater for function, replace if faulty. Check for uncontrolled sources of heat influencing the bay.

CO₂ System		
Displayed Error Code	Code Description	Checks and Corrections
CO₂ Over Set Point	- CO ₂ over set point	Perform CO ₂ sensor calibration Check injection solenoid for leaking valve Check sensor and disk filter for condensation
CO₂ Under Set Point	- CO ₂ time out error. The measured CO ₂ level has not reached within the allowed percentage in the allowed time. CO ₂ stops injecting and air is injected for 15 minutes in case the sensor is not detecting the CO ₂ .	Check CO ₂ gas supply - inline gas filters, CO ₂ gas tank pressure, CO ₂ sensor function Check/replace CO ₂ gas supply tanks Check for leaks in chamber inner door gasket, chamber recirculating tubes Check for leaks in air pump and hosing
Cal Inject Failed	- Cal inject calibration failed. Not enough increase in the CO ₂ reading after gas was injected.	Check gas supply then run calibration again Call NuAire Technical Services if error persists.

RH System		
Displayed Error Code	Code Description	Checks and Corrections
RH Level High	- RH over set point beyond the alarm limit	Perform RH sensor calibration Check injection solenoid for leaking valve Check sensor & moisture barrier in sensor cap for moisture
RH Level Low	- RH Level is below the set point beyond the alarm limit and the timer has counted down to zero	Perform RH sensor calibration Check RH tank for water level if low check Float switch in tank for function if Maintenance reminder does not appear in the MAIN screen Check for leaks in chamber Check for leaks in air pump and hosing Check sensor and inject solenoid for loose connections
Evaporator Temp low	-Water temperature in the water tank is below the alarm limit for 120 minutes	Check for loose connections on the tank heater Check for loose connections on the tank temperature sensor Check the tank heater for function replace if faulty.

O ₂ System		
Displayed Error Code	Code Description	Checks and Corrections
O₂ Under Set Point	- O ₂ under set point	Perform O ₂ sensor calibration Check injection solenoid for leaking valve Check sensor and disk filter for condensation
O₂ Over Set Point	- O ₂ time out error	Check O ₂ gas supply - inline gas filters, CO ₂ gas tank pressure, O ₂ sensor function Check/replace O ₂ gas supply tanks Check for leaks in chamber inner door gasket. Check for leaks in air pump and hosing

General Indicators		
Displayed Error Code	Code Description	Checks and Corrections
Door Ajar	- Inner glass door is not closed or switch not making connection with the control board.	Close and latch inner glass door. Confirm connection on the Control Board Check door switch, if faulty, replace.
“Power Interruption” Text instead of the NuAire Logo	- Interruption of power	Press the power interruption text to dismiss the notice.
Date/time flashing	- Interruption of power	Flashing Green: Indicates that the real time clock did not lose power. See section 8.7.1.1 to address this. Canceling or saving in the clock set screen will return to the main screen and stop the flashing. Flashing Yellow Indicates the real time clock lost backup power and needs to be set again. See section 8.7.1.1 to address this. Save must be pressed in the clock set screen to stop the flashing and return the date and time to green text.
Power Loss Recovery Mode	Displayed in main screen in place of RUN or STANDBY.	Shows when incubator has lost power for more than 45 minutes long enough to get condensation in the circulation system and cause the CO ₂ and O ₂ sensors to malfunction. This mode blocks circulation through the sensors and does not control the gas for 1 hour to allow the condensation to dissipate. Gas control is then resumed.
Corrupted Memory	Corrupted memory was detected during boot up of the incubator	Replace Control Board
Data Write Failure	A change in parameters failed to write to memory	Replace Control board
+12 VDC Power Failure	Low voltage detected on the +12 VDC power circuit	Check output @ Power Supply-If good could be Control Bd Check power supply connection to Control board DC power supply failed - replace
-12 VDC Power Failure	Low voltage detected on the -12 VDC power circuit	Check output @ Power Supply-If good could be Control Bd Check power supply connection to Control board DC power supply failed - replace
5 VDC Power Failure	Low voltage detected on the 5 VDC power circuit	Check output @ Power Supply-If good could be Control Bd Check power supply connection to Control board DC power supply failed - replace
Zero Cross Failure	The Power Triacs control circuit not working	Check for loose line voltage connection to control board Replace fuse with slow blow fuse of the correct amp rating as specified on the wiring diagram Replace Control Board
Universal Serial Bus Error	Stops trying to write to USB memory stick after several tries	Memory stick no compatible try another one. May take several tries USB port not functioning contact Nuair technical service

General Indicators		
Displayed Error Code	Code Description	Checks and Corrections
Condensation Excessive (Using Water Pan) See section 9 for more detailed instructions	On Glass Door	Increase Door heater duty cycle in 5% increments or less at a time
	On inner door gasket and/or front of the chamber	Increase Perimeter heater duty cycle in 5% increments or less.
	On any wall toward back of chamber	Decrease door then perimeter heater duty cycles in 5% increments or less.
Note: Depending on the room ambient that the Incubator is operating, the operator may have to readjust the door and perimeter heater duty cycle are too high and likewise if the door and perimeter heater duty cycles are too low the glass door and front wall of the chamber will show excessive condensation.		
Condensation Persists After Door and Perimeter Duty Cycles are Adjusted		Increase air injections, increasing duration first, recommended initial change to 15 sec (Air Inj) & 1 minute (Air Cyc)
Condensation on the face of the incubator outside of the chamber	Pressure in chamber high enough to cause blow by around the inner door gasket	Check side access port stopper pressure relief hole(s) for blockage. Check circulation system for blockage causing flow out of the chamber to be less than flow into the chamber.
Excess Vibration		Check jacket fan mounted on bottom of Incubator. Turn the incubator off. If the vibration persists it is from the room where the incubator is installed
Maintenance Required Button in Main Screen	Press button Message says it is time to change Filter	Check and Change filters in sensor bay and reset timer Check Filter and extend timer if filter doesn't need changing Extend Timer – See section 10.5 for more detail on all responses
	Message is RH Watertank	Fill with maximum 3 liters of distilled single water no purer Then 1 Mega Ohm – removes message on main screen

For further assistance, call NuAire Customer Service at 1-800-328-3352 or (763) 553-1270 USA.

12.0 Communication Outputs

12.1 Remote Alarm Contacts

The NuAire DHD Incubator contains a set of contact points to connect to a remote alarm system. The contacts are located on the rear panel (see page 14). The contacts are housed in a modular (RJ-11) telephone jack and rated for (30V at 1 Amp). The contacts provided are normally open (NO), normally closed (NC) and common (COM) as shown below. The alarm contacts do not distinguish between a CO₂ temperature and any other alarm. Each will open or close the contacts upon an alarm condition. Power interruption will also change the state of the contacts.

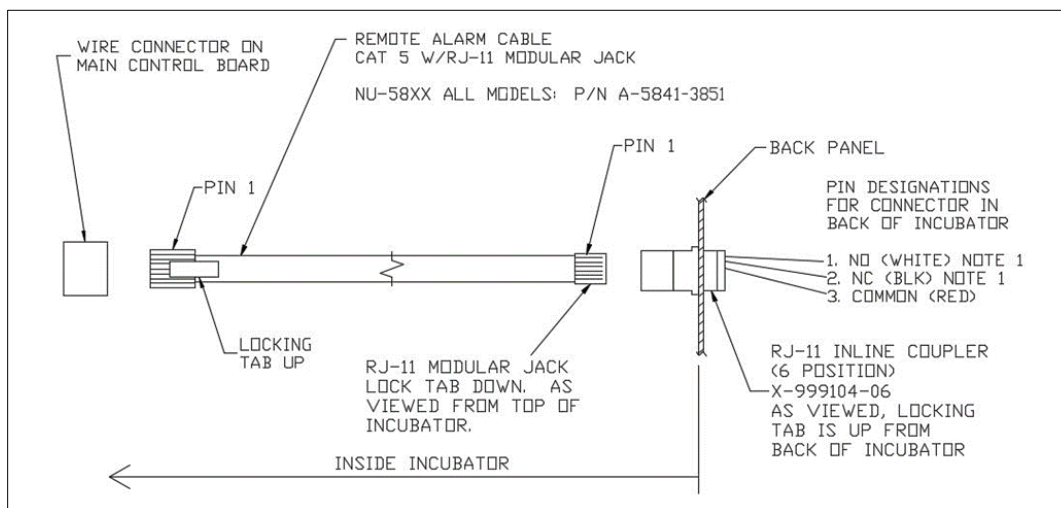

NOTE: The relay is powered when the incubator is turned on in order to detect a power interruption.

The relay contacts are in their normal state (NO, NC) when there is an alarm or during the loss of power to the incubator control board.

- 12.2 **4 to 20mA Analog System Performance Output:** Refer to PTB0235 Revision 3 or higher.
- 12.3 **RS-485 2-way Communications:** Refer to PTB0234
- 12.4 **On-Board USB Port:**
 - Uploading Service Performance/Event Data: Refer to STB0348
 - Uploading Incubator Programming: Refer to PTB0347



When connecting external accessories or components to the system, attach only components that have been tested and certified for compliance to UL/IEC 60601-1 or UL/IEC 60950

13.0 Electrical/Environmental Requirements

13.1 Electrical

Models: NU-5810, NU-5820, NU-5831 and NU-5841

Domestic Units:	115V,	50/60Hz,	1 Phase,	8.5 Amps
“E” Units:	230V,	50/60Hz,	1 Phase,	4.3 Amps

Start Up Power	625 Watts
Running Power	250 Watts
Decon Cycle	995 Watts

13.2 Operational Performance (for indoor use only)

Environment Temperature Range:	60°F-85°F (15.5°C – 29.4°C)
Environment Humidity:	Maximum relative humidity 80% for temperatures up to 31°C decreasing linearly to 50% relative humidity at 40°C
Environment Altitude:	6562 ft (2000 m) over sea level maximum

13.3 Light Exposure

Standard Fluorescent Lighting @ 150 ft. candles (1614 LUX) maximum intensity.

13.4 Installation Category: 2.0

Installation category (overvoltage category) defines the level of transient overvoltage, which the instrument is designed to withstand safely. It depends on the nature of the electricity supply and its overvoltage protection means. For example, in CAT II, which is the category used for instruments in installations supplied from a supply comparable to public mains such as hospital and research laboratories and most industrial laboratories, the expected transient overvoltage is 2500V for a 230V supply and 1500V for a 120V supply.

13.5 Pollution Degree: 2.0

Pollution degree describes the amount of conductive pollution present in the operating environment. Pollution degree 2.0 assumes that normally only non-conductive pollution such as dust occurs with the exception of occasional conductivity caused by condensation.

13.6 Chemical Exposure

Chemical exposure should be limited to antibacterial materials used for cleaning and disinfecting. Chlorinated and Halogen materials are not recommended for use on stainless steel surfaces. Chamber decontamination can be accomplished by paraformaldehyde, vapor phased Hydrogen Peroxide or Ethylene Oxide without degradation of cabinet materials.

13.7 EMC Performance (classified for light industrial)

Emissions:	EN61326
Immunity:	EN61326



Class A equipment is intended for use in an industrial environment. In the documentation for the user, a statement shall be included drawing attention to the fact that there may be potential difficulties in ensuring electromagnetic compatibility in other environments, due to conducted as well as radiated disturbances.

13.8 Heat Rejection: 14 BTU/Minutes.

14.0 Disposal and Recycle

Incubators that are no longer in use and are ready for disposal contain reusable materials. ALL components with the exception of the HEPA filters may be disposed and/or recycled after they are known to be properly disinfected.

NPTE: Follow all local, state and federal guidelines for disposal of HEPA filter solid waste.



BIOHAZARD



Prior to any disassembly for disposal the incubator must be decontaminated



RECYCLE



LEAD FREE

Component	Material
Incubator Cabinet	Painted Steel
Outer Door	Painted Steel
Chamber	Stainless Steel
Outer Door Gasket	Vinyl Clad Magnet
Inner Door Gasket	Silicon Rubber
Front Service Panel	Painted Steel
Electronics Panel	Painted Steel
Sensor Bay	Aluminum
Exhaust Filter	Aluminum
Hosing	Silicon Rubber
Tubing	Stainless Steel
Air Pump	Various Steel/Copper/Nylon
Motor	Various Steel/Copper/PVC
Printed Wiring Assembly	Lead Free Electronic
Wire	PVC Coated Copper
Solenoid Valves	Various Steel/Copper
Connectors	PVC
Hardware	Stainless Steel and Steel

NOTE: Material type can be verified with use of a magnet with stainless and aluminum being non-magnetic.

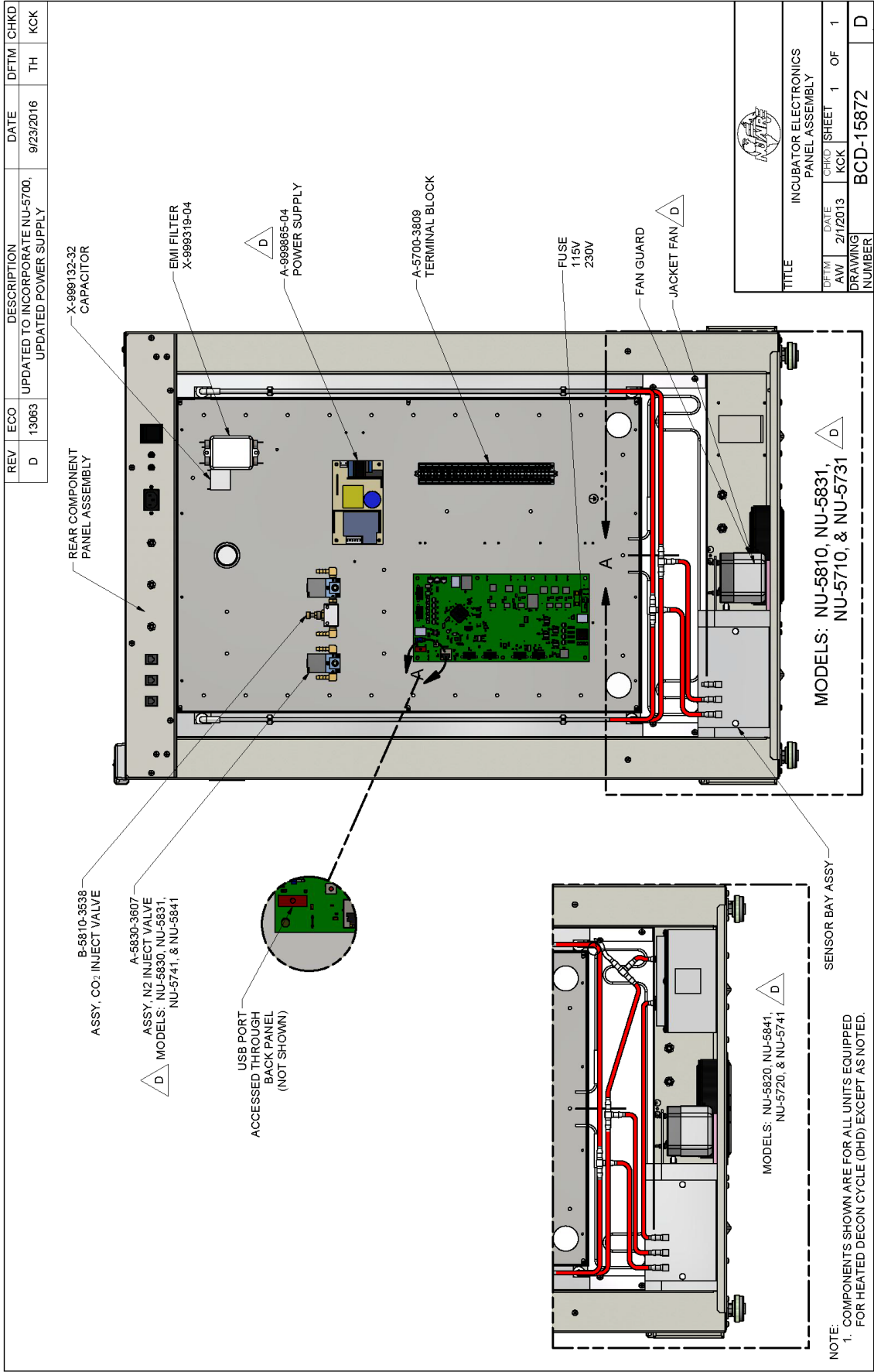

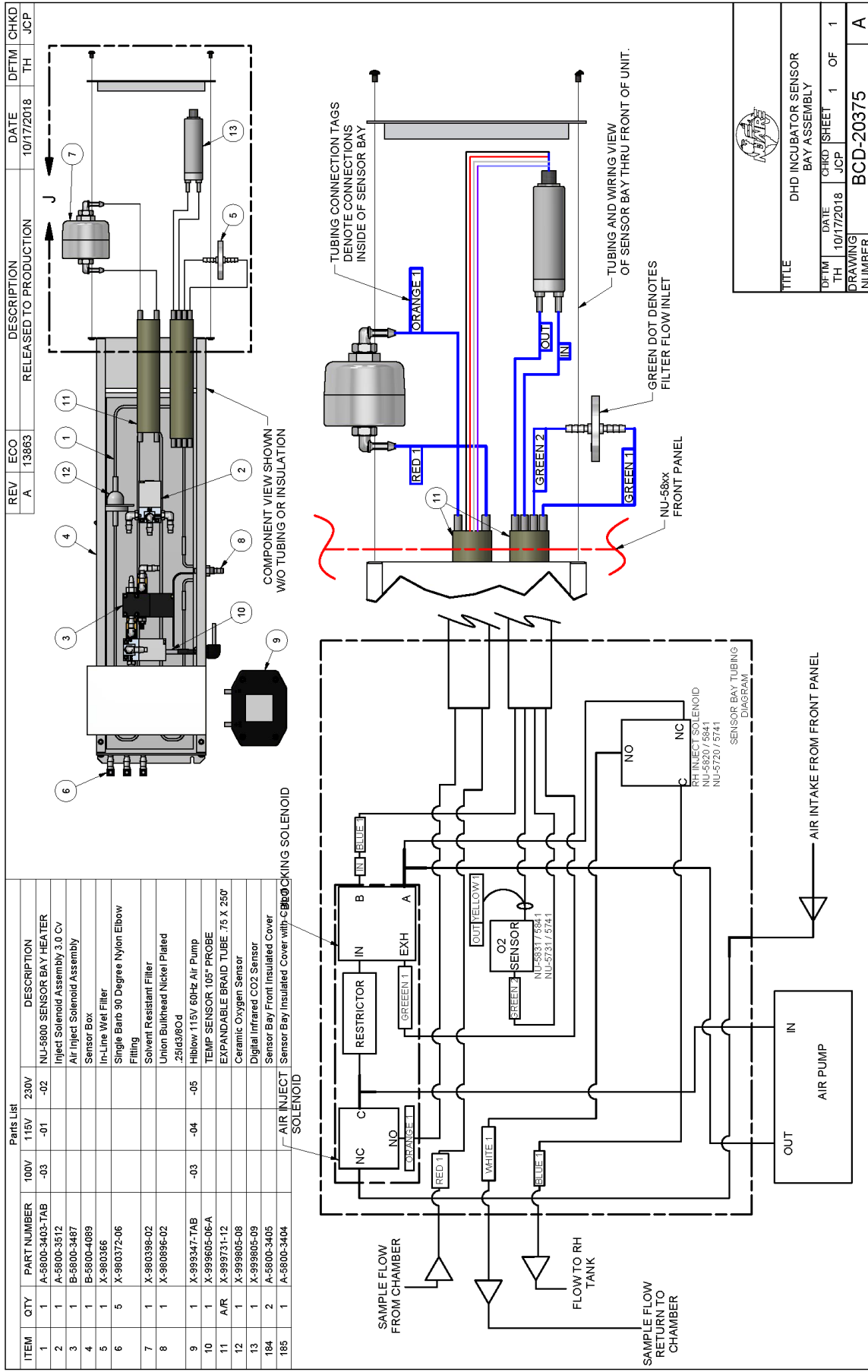

REV	ECO	DESCRIPTION	DATE	DFTM	CHKD
A	13863	RELEASED TO PRODUCTION	10/17/2018	TH	JCP

TITLE					
DHD INCUBATOR SENSOR BAY ASSEMBLY					
DFTM	DATE	CHKD	SHEET	1	OF
TH	10/17/2018	JCP	1	1	
DRAWING NUMBER					A
					BCD-20375

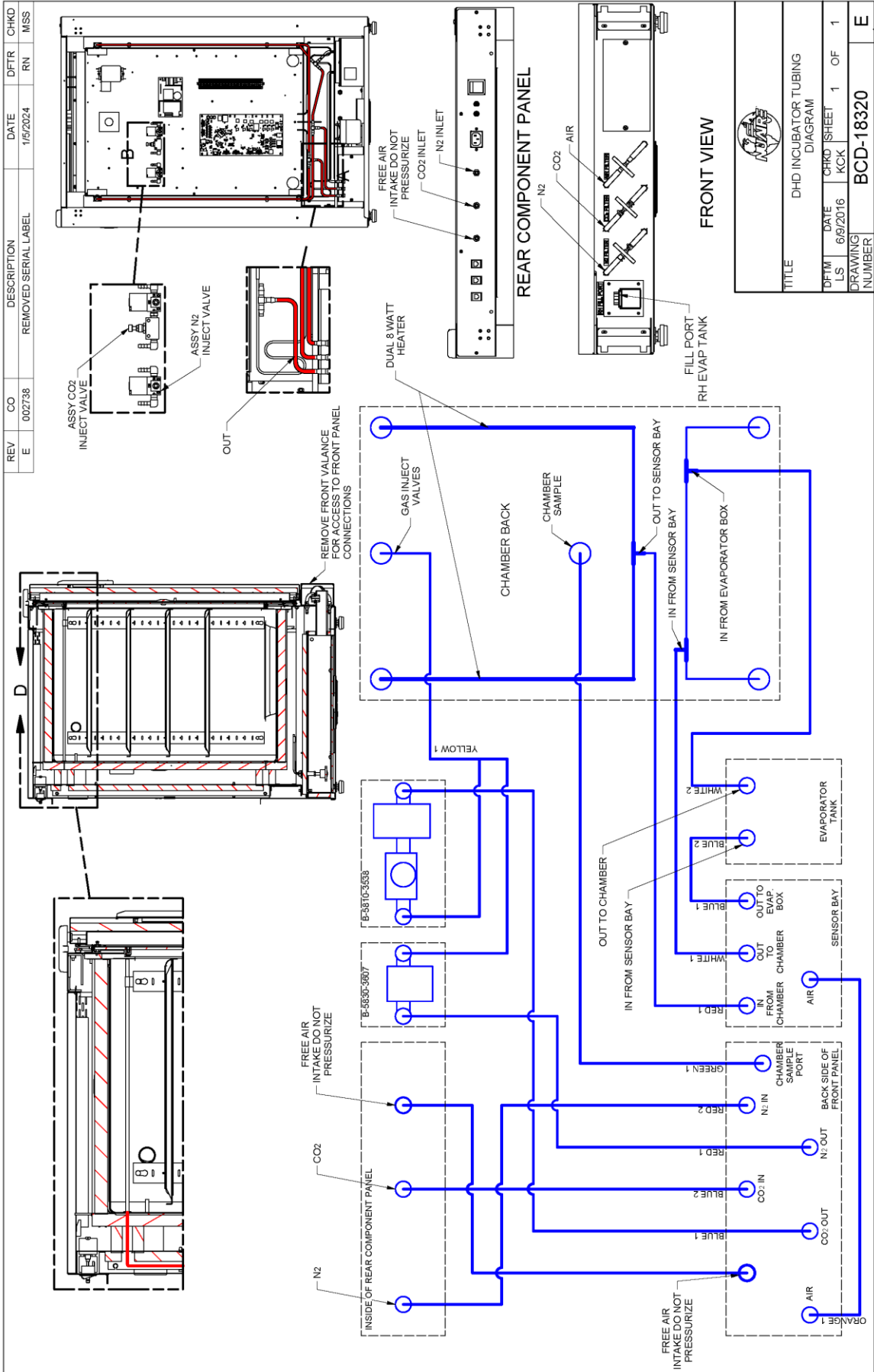

TITLE		DHD INCUBATOR TUBING DIAGRAM	
DFM LS	DATE	CHRD SHEET	OF
	6/9/2016	KKK	1 OF 1
DRAWING NUMBER		BCD-18320	
		E	

ITEM	QTY	NU-58XX P/N'S	NU-57XX P/N'S	DESCRIPTION
1	2	A-5800-3509	A-5800-3509	Lower Door Screen Harness
2	1	B-5800-3388	B-5700-3965	Top Panel
3	2	B-5800-3386	B-5800-3386	HINGE PIN MOUNT
4	1	B-5800-3389	B-5800-3389	Hinge Plate Cover
5	1	B-5800-3751	B-5800-3751	Top Plate Hinge (Series 3)
6	1	B-5800-3753	B-5700-3948	Lower Valance Panel (Series 3)
7	1	B-5800-3373	B-5700-3957	Rear Component Panel
8	4	X-980038-01	X-980038-01	Machine screw PPH #8-32 X 3/8 SST
9	2	X-980395-03	X-980395-03	Flanged Bushing 5/16" Shaft
10	24	X-980642-04	X-980642-04	Screw PPH #8-32 X .375 Waxed Tap SST
11	1	X-980783-03	X-980783-03	Washer #8 SAE SST
12	1	X-980795-01	X-980795-01	Lock Washer #8 Split SST
13	5	X-980815-03	X-980815-03	Lock Washer #8 Internal Tooth SST
14	2	X-980871-05	X-980871-05	Screw PTH #8-32 X 1/4 SST
15	2	X-989934-01	X-989934-01	WIRE NUT
16	1	B-5800-3384	B-5800-3384	Cover Plate
17	1	B-5800-3377	B-5700-3964	Inner Door Panel
18	1	A-5800-3491	B-5700-3941	Vinyl Magnetic Outer Door Gasket
19	20	X-980716-04	X-980716-04	Screw SPPH #8 X 1/2 (Waxed) SST
20	1	980-000110	980-000110	Incubator Front Panel Bezel
21	1	B-5800-3379	B-5800-3379	Display Mounting Panel
22	4	X-980633-04	X-980633-04	Set Screw #4-40 X 3/8 SST
23	1	B-5800-3549	B-5800-3549	RF Shield Display
24	4	X-980719-01	X-980719-01	Screw PPH #8-32 X 1/2 Black

Parts List

NO FASTENERS ONCE COMPONENT PANEL (ITEM 8) HAS BEEN UNSECURED, SLIDE TOP PANEL BACK AND LIFT UP TO REMOVE

DATA CABLE TO J13 ON CONTROL BOARD DISPLAY POWER WIRES TO J12 ON CONTROL BOARD

ROUTED TO CONTROL BOARD

WIRE INSULATOR SLEEVE X-999541-08 THRU HINGE PIN AND RECTANGULAR CUTOUT AT TOP OF UNIT TIE WRAPPED TO WIRES (SHOWN CUT AWAY)

DOOR HEATER LINE LEAD 115V BLACK 230V RED 100V BLUE

WIRE INSULATOR SLEEVE X-999541-08 UP THRU HINGE PIN INTO OUTER DOOR TIE WRAPPED TO WIRES (SHOWN CUT AWAY)

DOOR GROUND WIRE

ORAGNE AND GRAY WIRES TO LEFT SIDE OF INCUBATOR

HEATER LINE HEATER NEUTRAL DOOR GROUND THRU WIRE INSULATOR SLEEVE X-999541-06 (INSIDE OUTER DOOR)

ANTI-STATIC GROUNDING STRAP FROM DISPLAY COVER LABEL MOUNTED ON BEZEL

DETAIL B TOP RIGHT HINGE DETAIL

DETAIL A LOWER RIGHT HINGE DETAIL

DETAIL C LEFT SIDE LOWER CONNECTION

INCUBATOR RIGHT HINGE DOOR ASSEMBLY

DFM TH DATE 6/6/2016 KKK 1 OF 1

DRAWING NUMBER BCD-18317

REV	CO	DESCRIPTION	DATE	DFTR	CHKD
F	002738	REMOVED SERIAL LABEL	1/5/2024	RN	MSS

REV	CO	DESCRIPTION	DATE	DFTR	CHKD
F	002738	REMOVED SERIAL LABEL	1/5/2024	RN	MSS

ITEM	QTY	NU-58XX P/N'S	NU-57XX P/N'S	DESCRIPTION
1	2	A-5800-3509	A-5800-3509	Lower Door Screen Harness
2	1	B-5800-3388	B-5700-3965	Top Panel
3	2	B-5800-3386	B-5800-3386	HINGE PIN MOUNT
4	1	B-5800-3389	B-5800-3389	Hinge Plate Cover
5	1	B-5800-3751	B-5800-3751	Top Plate Hinge (Series 3)
6	1	B-5800-3753	B-5700-3948	Lower Valance Panel (Series 3)
7	1	B-5800-3373	B-5700-3957	Rear Component Panel
8	2	X-998934-01	X-998934-01	WIRE NUT
9	4	X-980395-01	X-980395-01	Machine screw PPH #6-32 X 3/8 SST
10	2	X-980395-03	X-980395-03	Flanged Bushing 5/8" Shaft
11	24	X-980642-04	X-980642-04	Screw PPH #8-32 X .375 Waxed Tap SST
12	1	X-980783-03	X-980783-03	Washer #8 SAE SST
13	1	X-980795-01	X-980795-01	Lock Washer #8 SST
14	5	X-980815-03	X-980815-03	Lock Washer #8 Internal Tooth SST
15	2	X-980871-05	X-980871-05	Screw PTH #8-32 X 1/4 SST
16	1	B-5800-3384	B-5800-3384	Cover Plate
17	1	B-5800-3377	B-5700-3964	Inner Door Panel
18	1	A-5800-3491	B-5700-3941	Vinyl Magnetic Outer Door Gasket
19	20	X-980716-04	X-980716-04	Screw SPFH #8 X 1/2 (Waxed) SST
20	1	980-000110	980-000110	Incubator Front Panel Bezel
21	1	B-5800-3379	B-5800-3379	Display Mounting Panel
22	4	X-980663-04	X-980663-04	Set Screw #4-40 X 3/8 SST
23	1	B-5800-3549	B-5800-3549	RF Shield Display
24	4	X-980719-01	X-980719-01	Screw PPH #8-32 X 1/2 Black

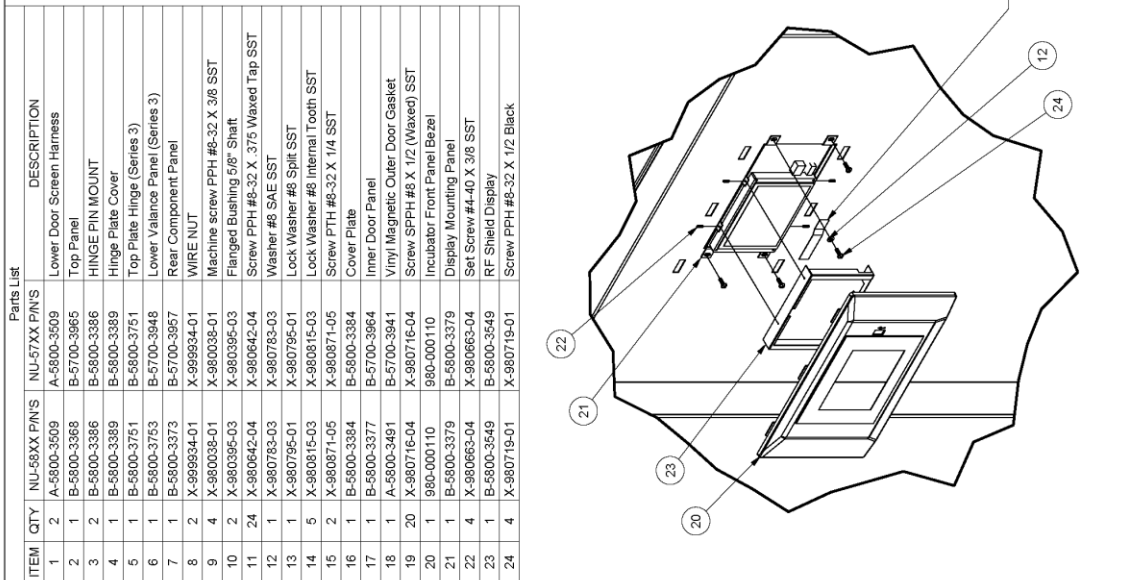

**DETAIL B
TOP LEFT
HINGE DETAIL**

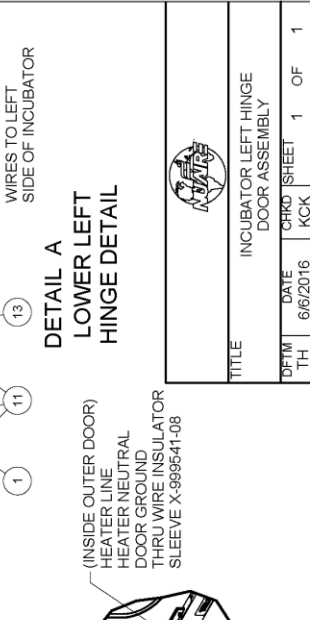
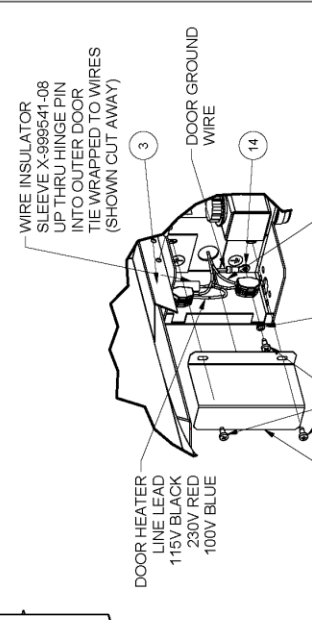
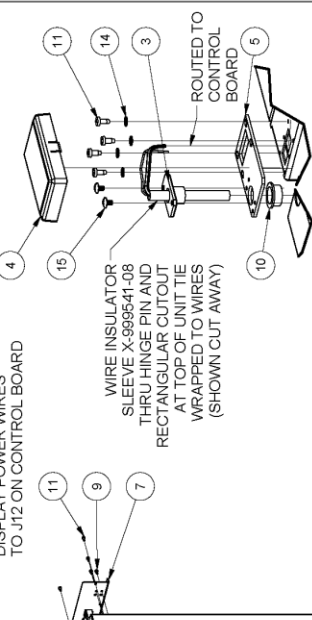

TITLE		INCUBATOR LEFT HINGE DOOR ASSEMBLY	
DFM TH	DATE	CHRD	SHEET
	6/6/2016	KCK	1 OF 1
DRAWING NUMBER		BCD-18321	
		F	

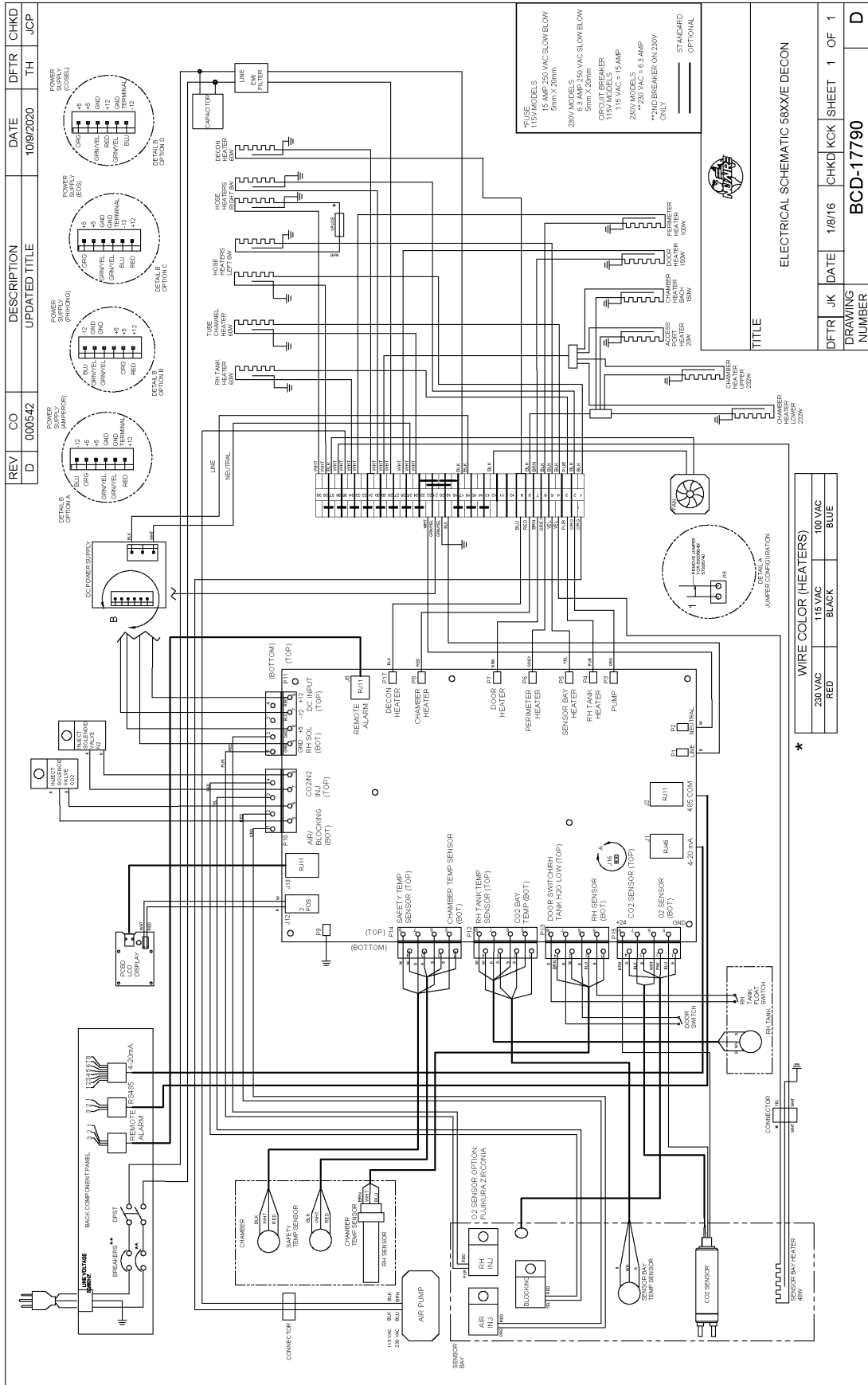

REV	ECO	DESCRIPTION	DATE	DRFT/CHKD
A	12870	RELEASED TO PRODUCTION	12/04/15	LS KCK

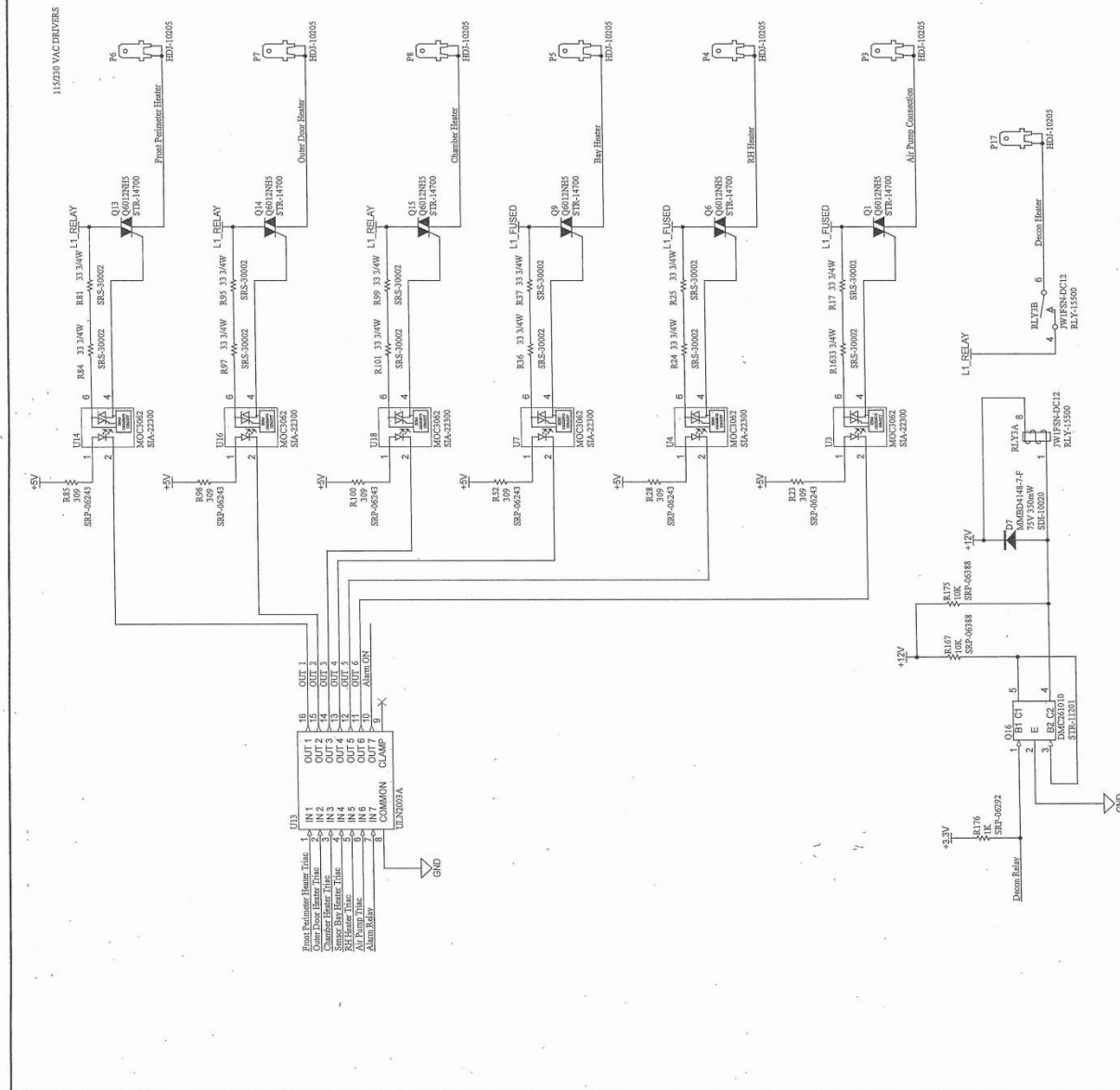



ORIGINAL

**NU-5800 CONTROL BOARD
OUTPUTS SCHEMATIC**

DFTM | LS | 12/04/15 | CHKD | KCK | SHEET 1 OF 1

DRAWING NUMBER **BCD-18007**