

# UVC/T-AR, UVC/T-M-AR, UVT-B-AR, UVT-S-AR DNA/RNA UV-cleaner boxes



If you have any feedback on our products or services, we would like to hear from you.  
Please send all feedback to:

**Manufacturer:**

SIA Biosan  
Ratsupites iela 7 k-2, Riga, LV-1067, Latvia

Phone: +371 674 261 37

Fax: +371 674 281 01

**[www.biosan.lv](http://www.biosan.lv)**

Marketing: [marketing@biosan.lv](mailto:marketing@biosan.lv)

Service: [service@biosan.lv](mailto:service@biosan.lv)

# Contents

1.	About this edition of user instructions.....	3
2.	Safety precautions .....	3
3.	General information.....	5
4.	Getting started.....	6
5.	Operation .....	7
6.	Specifications .....	9
7.	Ordering information .....	11
8.	Care and maintenance .....	12
9.	Storage and transportation .....	14
10.	Warranty.....	14
11.	EU Declaration of conformity.....	15

## 1. About this edition of user instructions

The current edition of the user instructions applies to the following models:

Model	Version
<b>UVC/T-AR</b> , DNA/RNA UV-cleaner box	V.3AD
<b>UVC/T-M-AR</b> , DNA/RNA UV-cleaner box	V.6A02, V.6A03, V.6A04, V.6AI and V.6A12
<b>UVT-B-AR</b> , DNA/RNA UV-cleaner box	V.4AB, V.4AD, V.4AE, V.4AI and V.4A12
<b>UVT-S-AR</b> , DNA/RNA UV-cleaner box	V.5AA, V.5AB, V.5A7, V.5AI and V.5A04

## 2. Safety precautions



**Caution!** Make sure you have fully read and understood present instructions before using the equipment. Please pay special attention to sections marked by this symbol.



**Caution!** The front protective screen must be closed while the open UV lamp is switched on. Otherwise, the operator can be exposed to a dangerous level of UV emission.



**Caution!** The unit contains a source of UV radiation. Do not start the unit without the cover of the UV recirculator. Exposure to UV light is harmful and can cause damage to unprotected eyes and skin.



**Caution!** The UV-Cleaner box contains a powerful source of UV radiation, therefore, before operating the unit, ensure all personnel working with the UV-Cleaner box are properly protected. The operator should wear a closed-front lab coat (fully buttoned), UV certified safety glasses and gloves, which should overlap the lab coat or surgical gown cuffs.

## 2.1 General safety

- The protection provided by the equipment may be impaired if the equipment is used with accessories (shelves, furniture) not provided or recommended by the manufacturer, or used in a manner not specified by the manufacturer.
- Save the unit from shocks and falling.
- Do not use the unit if it has visible mechanical damage.
- Store and transport the unit as described in the **Storage and transportation** section.
- Before using any cleaning or decontamination methods except those recommended by the manufacturer, check with the manufacturer that the proposed method will not damage the equipment.
- Do not make modifications in design of the unit.
- When handling hazardous substances, follow the instructions contained in the safety data sheets for the individual substances that are used and observe the relevant accident prevention regulations.

## 2.2 Electrical safety

- Connect only to the mains with voltage corresponding to that on the serial number label.
- Do not plug the unit into an ungrounded power socket, and do not use an ungrounded extension lead.
- Ensure that the power plug is easily accessible during use.
- Disconnect the unit from the mains before moving.
- If liquid penetrates into the unit, disconnect it from the mains and have it checked by a repair and maintenance technician.
- Do not operate the unit in premises where condensation can form. Operating conditions of the unit are defined in the **Specifications** section.

## 2.3 During operation

- Do not operate the unit in environments with aggressive or explosive chemical mixtures. Please contact manufacturer for possible operation of the unit in specific atmospheres.
- Do not operate the unit if it is faulty or has been installed incorrectly.
- Do not use outside laboratory rooms.
- Do not operate the unit without dust filters installed.
- Do not work in the box while the open UV lamp is switched on.

## 2.4 Biological safety

- The user is responsible to carry out appropriate decontamination if hazardous material spills on or penetrates into the equipment.
- The user is responsible for decontamination of the unit before its decommissioning and utilization.

### 3. General information

DNA/RNA UV-Cleaner boxes – **UVC/T-AR**, **UVC/T-M-AR**, **UVT-B-AR** and **UVT-S-AR** – are designed for clean operations with DNA/RNA samples. They provide protection against contamination.

All models are bench-top type, with metal framework, glass or acrylic walls and working surface painted with powder enamel or made of stainless steel. Box is equipped with inlet for power cables and built-in power outlets for units inside the box. For availability of the required characteristics, please clarify for each model separately (see 7.1 on page 11).

UV-Cleaner boxes are equipped with an open UV lamp installed in the upper hood. UV radiation from the open lamps disinfects the working area inactivating DNA/RNA fragments during 30 min of exposure. A digital timer controls duration of the direct UV irradiation. A daylight lamp provides proper illumination of the working surface.

UV-Cleaner box is equipped with a flowing bactericidal UV-cleaner-recirculator AR, which provides constant decontamination inside the box during operation. It is recommended for operations with DNA/RNA amplicons.

UV recirculator consists of an UV lamp (fig. 1/1), a fan and dust filters (fig. 1/2) organized in a plastic case. Operator working in a UV-Cleaner box with a switched on UV recirculator is not exposed to UV radiation. It allows continuous treatment of the airflow with UV light without interrupting working process. Air circulation at a short distance from the UV lamp combined with reflective surfaces in the air duct results in increased density of UV rays leading to higher efficiency of disinfection. UV recirculator generates 100 volumes of PCR cabinet per one hour of airflow exchange ensuring maximally aseptic conditions inside the cabinet.

Box for clean operations with DNA/RNA samples with built-in recirculator is a patented solution (patent LV13115 from 20/05/2004, Dr. biol. V. Bankovsky).

Microbiological studies at the R&D Department of Biosan led by Dr. biol. V. Bankovsky demonstrated a high level of biosafety and efficacy of UV-cleaner box (maximal level of contamination is 1-3 cfu per 100 litres of air)<sup>1</sup>.

UV-Cleaner box is designed to biologically protect the product, but not the operator, therefore, it is not recommended to use the UV-Cleaner box for working with pathogenic microorganisms of biosafety level BSL-II and higher, without specialized protection.

Advantages:

- UV-recirculator;
- Ozone free high density UV decontamination;
- Open UV lamp is switched off automatically in case of opening the front screen;
- Long life UV lamps (9000 h);
- Low noise level and energy consumption;
- Compact tabletop model for personal laboratories;
- Shelves for pipettes and reagents (on request)
- Table with drawer T-4 / T-4L, laboratory chest of drawers LF-1 (on request).

<sup>1</sup> See <http://biosan.lv/eval-en>

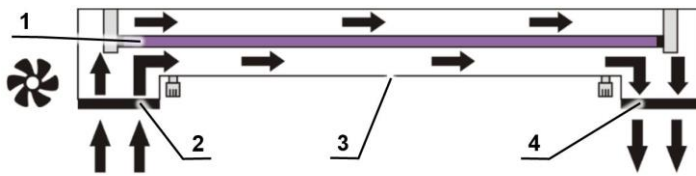

Figure 1. Recirculator scheme.

1. UV lamp. 2. Fan and input filter. 3. UV indicator. 4. Output filter

## 4. Getting started

4.1 **Unpacking.** Remove packing materials carefully and retain them for future shipment or storage of the unit. Examine the unit carefully for any damage incurred during transit. The warranty does not cover in-transit damage. Warranty covers only the units transported in the original package.



**Caution!** Due to the high weight of the unit, its unpacking and installing must be carried out by two persons. Follow the instructions included on the packaging.

4.2 **Complete set.** Package contents:

4.2.1 Standard set:

- DNA/RNA UV-cleaner box ..... 1 pce.
- Power cable (UVC/T-AR only)..... 1 pce.
- Spare fuse for control block<sup>1</sup> ..... 1 pce.
- Spare fuse for built-in power outlet<sup>2</sup> ..... 1 pce.
- Spare dust filters ..... 2 pcs.
- User instructions, declaration of conformity ..... 1 copy

4.2.2 Optional accessories:

- P-5, shelf for pipettes .....on request
- F-1, shelf for reagents and samples .....on request
- PDS-250, DNA/RNA Decontamination Solution Spray, 250 ml.....on request
- T-4 / T-4L moving table for UV-Cleaner box.....on request
- LF-1, laboratory chest of drawers.....on request



P-5



F-1



PDS-250

<sup>1</sup> For information on fuse replacement, see 8.3 on page 12

<sup>2</sup> For all models, excluding UVC/T-AR, see 7.1 on page 11



T-4



T-4L



LF-1

#### 4.3 Setup.

- If the moving table is used, unpack it carefully and assemble according to the enclosed assembling scheme.
- Place the unit upon stable surface. Ensure that the unit is placed on a solid, level surface not less than 720x550 mm (1290x600 mm for UVT-S-AR model), which is able to support its weight and the weight of equipment and materials inside, for instance on the T-4 / T-4L table.
- Position the unit with easy access to the power switch and plug.

#### 4.4 Shelf setup. Refer to the instructions included with the shelf.

## 5. Operation



**Note.** For **UVC/T-M-AR** and **UVT-B-AR** boxes, check that the short power cable (fig. 5/1) is connecting the fuse box and the controller top.

5.1 Connect the power plug to a grounded power socket. Turn on the **Power** switch:

- **UVC/T-AR** – no switch, the unit powers up automatically;
- **UVC/T-M-AR, UVT-B-AR** – on the right side of the unit, behind the rear wall (fig. 5/3);
- **UVT-S-AR** – on the left side of the unit, behind the rear wall (fig. 6/1).

5.2 UV exposition of the working place.



**Caution!** The front protective screen must be closed while the open UV lamp is switched on. Otherwise, the operator can be exposed to a dangerous level of UV emission.

5.2.1 Turn ON the switch **2** (fig. 2/2) on the control panel (fig. 3/1). This switches on the UV recirculator inside the unit (fig. 3/2) and the open UV-lamp exposition timer. The UV recirculator will operate all the time until the switch **2** is turned OFF.

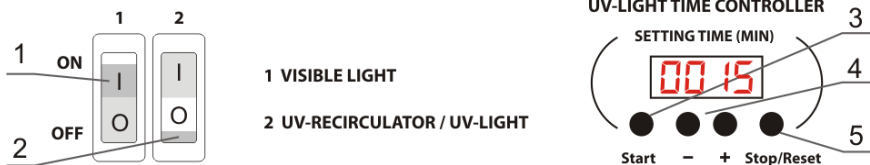

Figure 2. Control panel



**Note.** Open UV lamp operation can be checked with the visible light lamp switched off (switch **1** is OFF). Use the indicator in the centre of recirculator cover (fig. 1/3) to check operation of UV lamp inside the recirculator. If indicator lights from inside while switch **2** is ON, then the UV lamp is functioning.

5.2.2 Use the timer **+** and **-** keys (fig. 2/4) to increase and decrease the time (SETTING TIME) of direct UV light exposition of the working place, with 1 min increment. Pressing down and holding the button for more than 2 seconds increases the increment. Recommended time of exposition is two sessions of 30 minutes, once after switching on the cabinet, once before operations inside.



**Note.** When using the **P-5** and **F-1** shelves, extend the exposition time to two sessions of 45 minutes.

5.2.3 Press the **Start** key (fig. 2/3), the UV lamp will be turned on automatically and the timer will start counting the exposition time. Timer indicator shows actual time: until 1 hour - in minutes and seconds (mm:ss), after 1 hour - in hours and minutes (hh:mm). After reaching the set time the timer will automatically turn off the open UV lamp.

5.2.4 The open UV lamp can be switched off by pressing the **Stop/Reset** key (fig. 2/5). The set time of exposition will be saved in the memory. The set time will not be saved after the complete turning off the unit.

5.2.5 If the set time of open UV light exposition is 0:00, pressing the **Start** key will make the unit operate continuously during 24 hrs or until the **Stop/Reset** key is pressed.

5.3 The box is ready for operations. Work in the box.



**Note.** Opening the front protective screen will switch off the open UV lamp automatically, but the timer will continue counting the exposition time.

5.3.1 Turn ON switch **1** (fig. 2/1) for lighting of the working place. This turns ON the luminescent (visible light) lamp inside the cabinet (fig. 3/3).

5.3.2 Lift the front protective screen (fig. 3/5) up for work in the cabinet. Models have different maximum opening heights (fig. 3/8), as listed in the **Specifications** section, and may be raised to the following positions:

- Model **UVC/T-AR** has a single opening height;
- Models **UVC/T-M-AR**, **UVT-B-AR** and **UVT-S-AR** has three protective screen positions – one-third, two-thirds and full opening height.



**Note.** Do not block the recirculator openings (fig. 3/2)!

5.3.3 To use electric devices inside the cabinet, pull their power cable through the inlet and close the flap (fig. 3/6) or connect the power cable to a built-in mains socket (fig. 3/7, models with mains socket).



**Caution!** Overall consumed power of devices connected through internal mains sockets should not exceed 1000 W for 230V, or 600 W for 100–120 V.

5.4 After the task is done, close the front protective screen.

5.5 After finishing the operation turn OFF switch **2** and switch **1**. Turn off the **Power** switch, if present. Disconnect the power cable from the mains.



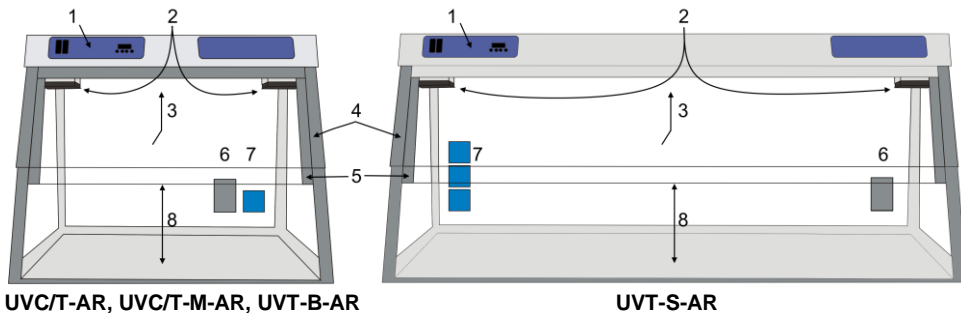

Figure 3. DNA/RNA UV box, frontal view:

1. Control panel. 2. Recirculator openings. 3. Daylight lamp and open UV lamp(s).
4. Upper front panel. 5. Movable front protective screen (opened). 6. Cable inlet.
7. Power outlet(s) (not in UVC/T-AR). 8. Opening height.

## 6. Specifications

The unit is designed for operation in cold rooms and closed laboratory rooms at ambient temperature from +4°C to +40°C in a non-condensing atmosphere and maximum relative humidity 80% for temperatures up to 31°C decreasing linearly to 50% relative humidity at 40°C.

Biosan is committed to a continuous programme of improvement and reserves the right to alter design and specifications of the equipment without additional notice.

Model	UVC/T-AR Compact	UVC/T-M-AR Compact	UVT-B-AR Compact	UVT-S-AR Double
Back panel	PMMA	Steel		
Side panels		Glass	Coated steel	Glass
Front panel and screen		Glass		
Working surface	Coated steel	Steel		
Open UV lamp	1x TUV 25W G13 UV-C			2x TUV 30W G13 UV-C
UV intensity	18 mW/cm <sup>2</sup> /s			
Radiation type	Ultraviolet light ( $\lambda=253.7$ nm), no ozone			
Time setting of direct UV exposure	Digital timer, 1 minute - 24 hours / non-stop (increment 1 minute)			
UV recirculator lamp	1x TUV 25W G13 UV-C			1x TUV 30W G13 UV-C
Visible light lamp	1x TLD 15W G-13			1x TLD 30W G-13
Thickness of side panels	4 mm	4 mm	2 mm	4 mm
Thickness of upper front panel	8 mm			
Thickness of protective screen	8 mm	4 mm	4 mm	5 mm
Optical transparency	92%			95%
UV protection	> 99.90%			> 96%

Model	UVC/T-AR Compact	UVC/T-M-AR Compact	UVT-B-AR Compact	UVT-S-AR Double
Noise level	< 45 dB			< 47 dB
Working surface	490x645 mm			500x1210 mm
Opening height	165 mm	190 mm (max 210 mm)		190 mm (max 220 mm)
Opening levels	Full height	1/3, 2/3 and full height		
Power inside the box (see 7.1)	Cable inlet	Cable inlet and 1 socket <sup>1</sup>		Cable inlet and 3 sockets <sup>4</sup>
Operating current	100–240 V, 50/60 Hz			
Power consumption	67 W			135 W
Dimensions	720x535x555 mm	700x580x555 mm		1250 x 600 x 590 mm
Weight (net/gross) <sup>2</sup>	23 / 33 kg	28.8 / 39 kg	31.2 / 42 kg	58 / 68.5 kg
Laboratory table	T-4			T-4L

### 6.1 Used materials.

- PMMA – polymethylmethacrylate (acrylic) glass, Altuglas® EX.
- Glass – clear film (0.1 mm) coated glass, Euroglas®.
- Steel – stainless polished steel.
- Coated steel – white enamel powder coated steel.

### 6.2 Cabinet dimensions. Outer and inner dimensions, opening heights.

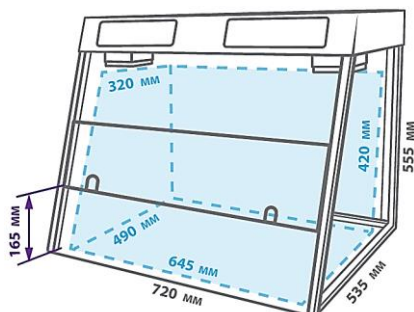

UVC/T-AR

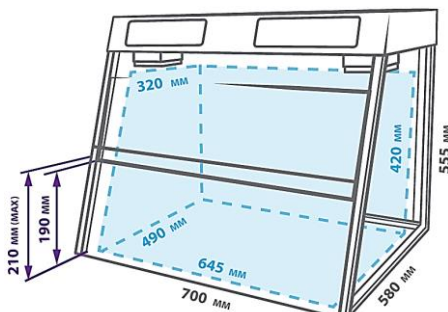

UVC/T-M-AR, UVT-B-AR

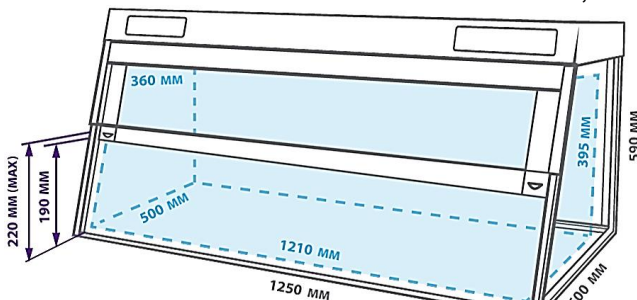

UVT-S-AR

<sup>1</sup> **Warning!** Overall consumed power of devices connected through internal mains sockets should not exceed 1000 W for 230V, or 600 W for 100–120 V

<sup>2</sup> Accurate within ±10%

## 7. Ordering information

### 7.1 Models and versions available:

Model	Version	Power inside the cabinet		Catalogue number
		Cable inlet	Socket	
UVC/T-AR	V.3AD	1	–	BS-040102-AAA
UVC/T-M-AR	V.6A02	1	1 x EU (type E/F)	BS-040104-A06
	V.6A03	1	1 x UK (type G)	BS-040104-A07
	V.6A04	1	1 x US (type B)	BS-040104-A08
	V.6A12	1	1 x AU (type I)	BS-040104-A24
	V.6AI	1	1 x IL (type H)	BS-040104-AIL
UVT-B-AR	V.4AD	1	1 x EU (type E/F)	BS-040109-A06
	V.4AE	1	1 x UK (type G)	BS-040109-A07
	V.4AB	1	1 x US (type B)	BS-040109-A08
	V.4A12	1	1 x AU (type I)	BS-040109-A24
	V.4AI	1	1 x IL (type H)	BS-040109-AIL
UVT-S-AR	V.5AA	1	3 x EU (type E/F)	BS-040107-AAA
	V.5AB	1	3 x UK (type G)	BS-040107-AAB
	V.5A7	1	3 x US (type B)	BS-040107-AA7
	V.5A04	1	3 x AU (type I)	BS-040107-A04
	V.5AI	1	3 x IL (type H)	BS-040107-AIL



**Caution!** Overall consumed power of devices connected through internal mains sockets should not exceed 1000 W for 230V~, or 600 W for 100–120 V~.

7.2 To inquire about or order the optional accessories, contact Biosan or your local Biosan representative.

#### 7.2.1 Optional accessories:

Optional accessories	Catalogue number
<b>PDS-250</b> , DNA/RNA decontamination solution spray, 250 ml	BS-040107-DK
<b>P-5</b> , shelf for 5 pipettes	BS-040104-CK
<b>F-1</b> , shelf for samples and reagents, work area 400x140 mm	BS-040104-DK
<b>T-4</b> , movable table with a drawer and wheel locks, dimensions 800x600x745 mm	BS-040101-BK
<b>T-4L</b> , movable table with a drawer and wheel locks, dimensions 1290x600x770 mm	BS-040107-BK
<b>LF-1</b> , laboratory chest of drawers with 5 drawers	BS-050101-BK

## 8. Care and maintenance

### 8.1 Service.

- 8.1.1 If the unit is disabled (e.g., lamps not working, no reaction on key and switch presses) or requires maintenance, disconnect the unit from the mains and contact Biosan or your local Biosan representative.
- 8.1.2 All maintenance and repair operations (except listed below) must be performed only by qualified and specially trained personnel.
- 8.1.3 Operating integrity check. If the unit follow the procedure described in section **Operation**, then no additional checks are required.

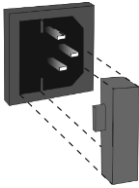

Figure 4.

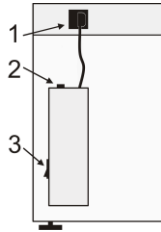

Figure 5

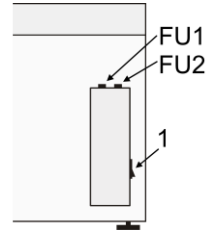

Figure 6

### 8.2 Fuse replacement.

- 8.2.1 Fuse for the control box. Disconnect the unit from electric circuit. Remove power cable from its socket on the rear side of the unit. Open the fuse holder by pulling out the holder (fig. 4, compact models) or by screwing off the holder lid marked FU2 (fig. 6, model **UVT-S-AR**). Check the fuse and replace if necessary, **M** 3.15 A (type **M** - time lag: **Medium**).
  - 8.2.2 Fuse for the mains outlets (for models with built-in mains outlets). Disconnect the unit from electric circuit. Open the fuse holder by screwing off the holder lid (fig. 5/2 or fig 6, FU1). Check the fuse and replace if necessary, **M** 5.0 A (type **M** - time lag: **Medium**).
- 8.3 **UV lamp replacement.** Average lifetime of UV lamps supplied is 9000 hrs. Replacement is necessary after lamp stops functioning or at the end of manufacturer specified lifetime.



#### Note.

Open UV lamp operation can be checked with the visible light lamp switched off (switch **1** is OFF). Use the indicator in the centre of recirculator cover (fig. 1/3) to check operation of UV lamp inside the recirculator. If indicator lights from inside while switch **2** is ON, then the UV lamp is functioning.

8.4 **Dust filter replacement.** The dust filters (fig. 3/2) on either end of the UV recirculator with the hidden UV lamp should be checked monthly and cleaned or replaced when they become clogged. To check, replace or clean the filters, simply unclip the covers, fit a new filter if necessary or rinse current filters in water, dry and place back. Clip covers back in place.

8.5 **Cleaning and decontamination.** Disconnect from the mains before cleaning.



**Caution!** Do not let liquid get into the control box.

8.5.1 Model **UVC/T-AR** and shelves **P-5** and **F-1**, full cleaning. Transparent panels and shelves are made of acrylic glass (polymethylmethacrylate Altuglas® EX) and are prone to scratches and optical transmission capacity decrease if improperly cleaned. Use mild soap and water with a soft cloth or sponge for cleaning the panels. Rinse remaining washing solution with distilled water. Wipe dry the excess water with clean soft cloth or sponge.

For decontamination, we recommend using a special DNA/RNA removing solution (e.g. Biosan **PDS-250**). After washing the inside parts of the box it is necessary to rub them dry.



**Caution!** Never use organic solvent based compounds, pure alcohol, alcohol-containing cleaners (more than 20%) or ammonia containing cleaners for acrylic glass. Do not use abrasives. The table below shows the interaction of acrylic glass with ethyl alcohol and other solutions.

Solution	Interaction with acrylic glass
Biosan PDS-250	No effect
DNA-Exitus Plus™	No effect
RNase-Exitus Plus™	No effect
Hydrogen peroxide H <sub>2</sub> O <sub>2</sub> 6%	No effect
Ethanol C <sub>2</sub> H <sub>5</sub> OH ≤ 20%	No effect
Ethanol C <sub>2</sub> H <sub>5</sub> OH > 20%	Increasing effect. Do not use.



**Note.** crazing is a normal process for acrylic glass panels exposed to open UV light. Crazing will occur over time. Crazing may occur within the warranty period and is regarded as normal wear and not covered by the warranty. Acrylic glass panels can be replaced.

8.5.2 Models **UVC/T-M-AR**, **UVT-B-AR** and **UVT-S-AR**, external cleaning. Glass panels on the outside are coated in 0.1 mm (4 mil) clear film for UV protection. Use mild soap and water with a soft cloth or sponge for cleaning the panels. Rinse remaining washing solution with distilled water. Wipe dry the excess water with clean soft cloth or sponge. Do not use ethanol or other organic solvents.

8.5.3 Models **UVC/T-M-AR**, **UVT-B-AR** and **UVT-S-AR**, internal cleaning and decontamination. The following substances are recommended to use for decontamination: 75% ethanol, sodium hypochlorite solution, DNA/RNA removing solution (e.g. Biosan **PDS-250**). After washing the inside parts of the box it is necessary to wipe them dry.

## 9. Storage and transportation

- 9.1 Store and transport the unit in a horizontal position (see package label) at ambient temperatures between -20°C and +60°C and maximum relative humidity of 80%.
- 9.2 After transportation or storage and before connecting it to the electric circuit, keep the unit under room temperature for 2-3 hrs.
- 9.3 Extended storage of the unit does not require special procedures.

## 10. Warranty

- 10.1 The Manufacturer guarantees the compliance of the unit with the requirements of Specifications, provided the Customer follows the operation, storage and transportation instructions.
- 10.2 The warranted service life of the unit from the date of its delivery to the Customer is 24 months. For extended warranty, see **10.5**.
- 10.3 Warranty covers only the units transported in the original package.
- 10.4 If any manufacturing defects are discovered by the Customer, an unsatisfactory equipment report shall be compiled, certified and sent to the local distributor address. To obtain the claim form, visit **Technical support** page on our website at link below.
- 10.5 Extended warranty.
  - For **UVC/T-M-AR & UVT-S-AR**, the *Premium* class model, one year of extended warranty is available free of charge after registration, during 6 months from the date of sale. Online registration form can be found in section **Warranty registration** on our website at the link below.
  - For **UVC/T-AR & UVT-B-AR**, the *Basic Plus* class model, extended warranty is a paid service. Contact your local Biosan representative or our service department through the **Technical support** section on our website at the link below.
- 10.6 Description of the classes of our products is available in the **Product class description** section on our website at the link below.

### Technical support



[biosan.lv/en/support](https://biosan.lv/en/support)

### Registration



[biosan.lv/register-en](https://biosan.lv/register-en)

### Product class description



[biosan.lv/classes-en](https://biosan.lv/classes-en)

- 10.7 The following information will be required in the event that warranty or post-warranty service comes necessary. Complete the table below and retain for your records.

Model	Serial number	Date of sale
<b>UVC/T-AR, UVT-B-AR, UVC/T-M-AR, UVT-S-AR, DNA/RNA UV-cleaner box</b>		

## 11. EU Declaration of conformity

# EU Declaration of Conformity

**Unit type** DNA/RNA UV-cleaner boxes

**Models** UVC/T-AR, UVC/T-M-AR, UVT-B-AR, UVT-S-AR

**Serial number** 14 digits styled XXXXXXYYMMZZZZ, where XXXXXX is model code, YY and MM – year and month of production, ZZZZ – unit number.

**Manufacturer** SIA BIOSAN  
Latvia, LV-1067, Riga, Ratsupites 7 k-2

The objects of the declaration described above is in conformity with the following relevant Union harmonization legislations:

<b>LVD 2014/35/EU</b>	<b>LVS EN 61010-1:2011</b> Safety requirements for electrical equipment for measurement, control, and laboratory use. General requirements.
<b>EMC 2014/30/EU</b>	<b>LVS EN 61326-1:2013</b> Electrical equipment for measurement, control and laboratory use. EMC requirements. General requirements.
<b>RoHS3 2015/863/EU</b>	Directive on the restriction of the use of certain hazardous substances in electrical and electronic equipment.
<b>WEEE 2012/19/EU</b>	Directive on waste electrical and electronic equipment

I declare that the Declaration of Conformity is issued under sole responsibility of the manufacturer and belongs to the above-mentioned objects of the declaration.

Svetlana Bankovska  
Managing director



\_\_\_\_\_  
Signature

07.02.2020.  
\_\_\_\_\_  
Date

**Biosan SIA**

Ratsupites 7 k-2, Riga, LV-1067, Latvia

Phone: +371 67426137 Fax: +371 67428101

**<http://www.biosan.lv>**

Edition 3.-6.02 – March of 2021