



LABGUARD *DES AIR*

NU-543 CLASS II TYPE A2 BIOSAFETY CABINET



The Safer Choice for Your Laboratory, Pharmacy, and You.

Designed By You. Designed for your Application.



environmental,
product & personnel
protection

The LabGard[®] ES (Energy Saver) AIR model NU-543 is a Class II, Type A2 Biological Safety Cabinet offering Personnel, Product, and Environmental Protection through the use of quality design, an ultra-high-efficiency motor, and longer lasting filters all at an affordable price.

You deserve a quality and robust Biological Safety Cabinet every time you sit down to work. Every NuAire Biological Safety Cabinet goes through a series of quality assurance checks before it reaches your laboratory. As your product moves through the assembly plant, each work station double checks the work of the previous station,

filters are triple-checked, and biological tests are continually being performed under dynamic conditions to ensure maximum safety.

Each cabinet is built to order for your application. It is as simple as including an additional service valve or as complex as developing the interior to fit a specific piece of machinery.

Our local sales representatives are the best in the industry. They assist with product selection, built-in options, and accessories, discuss pricing, offer installation guidance, and provide support over the life of your NuAire product.

Flexibility and Innovative Design

Maximum Access Flexibility

Select from three window access opening options to meet the concerns of your facility and/or staff.

- **8"** (203 mm) lower operating cost (NSF/ANSI 49)
- **10"** (254 mm) lower costs and improved ergonomics (NSF/ANSI 49, EN12469)
- **12"** (305 mm) improved ergonomic reach by 40%* (NSF/ANSI 49)

* As compared to an 8" (203 mm) access opening.

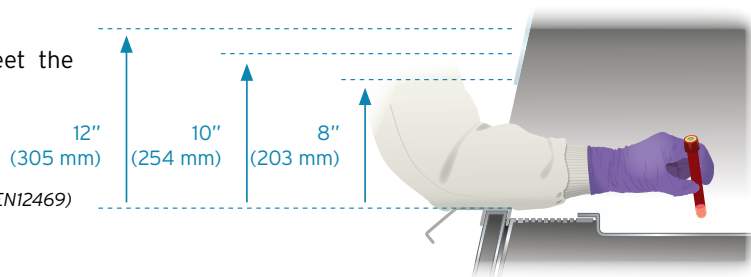

Ultra High Efficiency Motor

A single ultra-high efficiency ECM motor with a precision engineered fan blade minimizes energy usage while extending the life of filters. LabGard® offers the lowest total cost of ownership compared to other models.



A Size to Fit Your Facility or Application

← 3 FT (0.9 M) →



← 4 FT (1.2 M) →



← 5 FT (1.5 M) →



← 6 FT (1.8 M) →



Ergonomic Design

NuAire designs equipment for you that provides improved safety conditions; improved productivity; improved quality and reliability; and reduction of arm, shoulder, and neck strain which can contribute to common work place injuries.



- ADA Compliant
- More Usable Work Area
- Shorter Reach Into Work Zone
- Recessed Air Foil
- Recessed Work Zone
- More Knee Room
- Ability to Sit or Stand at a Range of Heights
- 21" (533 mm) Frame-less Edge Window Sash Improves Vision/Sight Lines Into Work Zone
- Staggered Service Valves
- Accessories: Elbow rests, Armrest Foam Pads, Ergo chair, Adjustable Base Stand, Stainless Steel Turntable

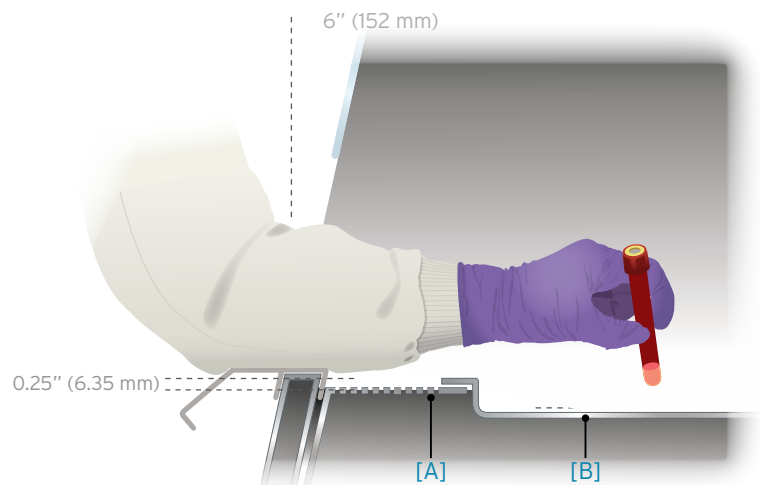

A recessed airfoil grill **[A]** allows users to use the ergonomic armrest without blocking airflow compromising safety. A recessed work tray **[B]** provides users greater flexibility when working with bottles or pipettes. A shorter reach into the work zone allows users to bring work closer without sacrificing safety. These are just some of the user focused ergonomic designs NuAire® incorporates into all our laboratory products.

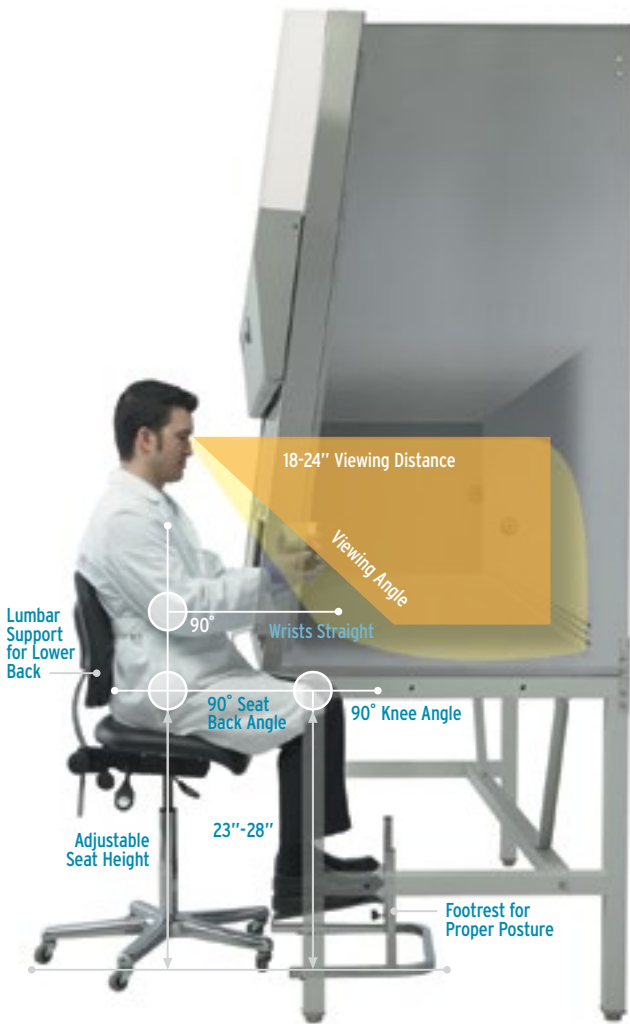

[Larger Work Area]



[Expanded Vision Zone]

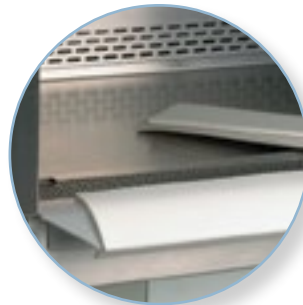

[Disposable Arm Rest Pads]



[Recessed Airfoil Grill and elbow rest accessory]

Quality - Nothing is Built like a NuAire

Monolithic Design. At core of any biosafety cabinet is its basic structure. NuAire has over 100,000 biosafety cabinets in the field; some of which have been running strong since the 1970's.

The NuAire design is a pressure tight, single piece of type 304 stainless steel. A stainless steel wrap **[A]** makes up the walls of the cabinet. Stainless steel sheets **[B]** are seam welded in place to make up the top and bottom of the cabinet. A smaller wrap **[C]** featuring covered interior corners is seam welded in place to make up the back and side walls of the cabinet. This improves the cabinet integrity by creating a double sidewall. Work tray supports **[D]** help minimize the vibration transfer from the shell of the cabinet to the work zone.

The end result is a pressure tight monolithic shell of 100% stainless steel **[E]** without the use of silicone like many multi-piece cabinets. This provides you with a solid foundation for longer product life eliminating potential leaks.

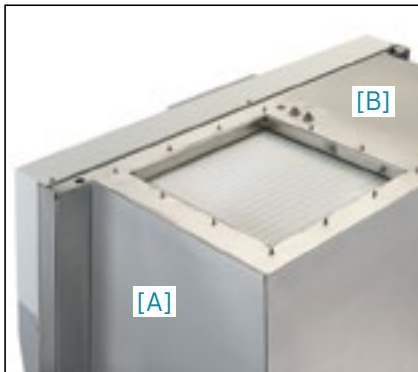

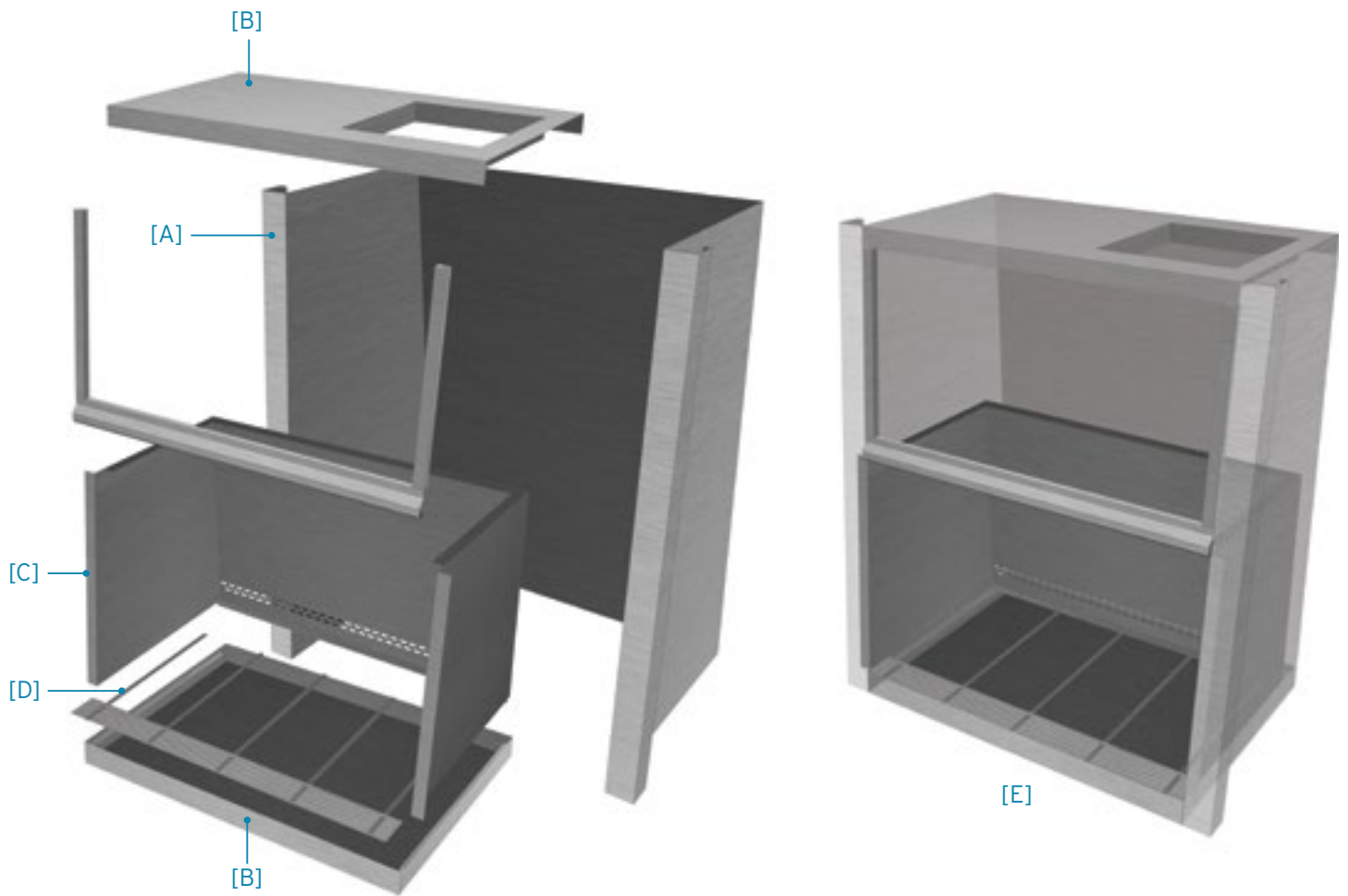

Save More Money Over a Longer Period of Time

Ultra High Efficiency Motor. An ultra-high efficiency ECM motor combined with the properly sized fan blade lowers energy usage while extending the life of filters. LabGard® offers the lowest total cost of ownership compared to other models.

Total cost of ownership breakdown.

Motor Comparison	NuAire DC ECM	NuAire AC PSC	BSC with AC 3-Phase	BSC with DC
8 hrs per day / 5 days per week = 2,000 hrs per year				
KWH per year	598	1128	828	326
\$0.09/kwh	\$54	\$102	\$75	\$29
24 hrs per day / 7 days per week = 8,736 hrs per year				
KWH per year	2612	4927	3617	1424
\$0.09/kwh	\$235	\$443	\$326	\$128
15 Year Life Cycle Costs				
Avg. Filter Changes*	1 Set	2 Sets	1 Set	3 Sets
Estimated Cost of HEPA Filters	\$715	\$1,430	\$715	\$2,145
Total Cost of Decon/Certification	\$450	\$900	\$450	\$1,350
Motors to Replace**	1 Motor	1 Motor	1 Motor	2 Motors
Cost of Motors/ Power Supplies/ Fan Control	\$650	\$420	\$725	\$2,544
Utility Costs (2,000 hrs/yr over 15 years)	\$810	\$1,530	\$1,125	\$435
Total Cost of Ownership	\$2,625	\$4,280	\$3,015	\$6,474

* Estimate based on Filter Load capacity

** Estimate based on historical information.

Disclaimer: This example is for illustrative purposes only and should not be deemed a representation of future performance or a guarantee of any kind. Information is based on internal performance data obtained through NuAire® testing and information provided by motor, blower, HEPA filter manufacturers, and independent service technicians.

Efficient, Quiet, Powerful

The LabGard® AIR comes standard with an Ultra High Efficiency Motor. Each motor has a precision engineered blower fan to maximize energy efficiency and filter life. The more powerful motor in model NU-543 equates to longer filter life lowering your total cost of ownership.

Power Savings

Model	Nominal Width	Motor Power	Savings*
NU-543-300	3 ft (0.9 m)	¾ HP	59%
NU-543-400	4 ft (1.2 m)	¾ HP	
NU-543-500	5 ft (1.5 m)	1 HP	
NU-543-600	6 ft (1.8 m)	1 HP	

* Compares NuAire DC ECM motor technology and a BSC featuring DC motor technology. Information taken from page 7.

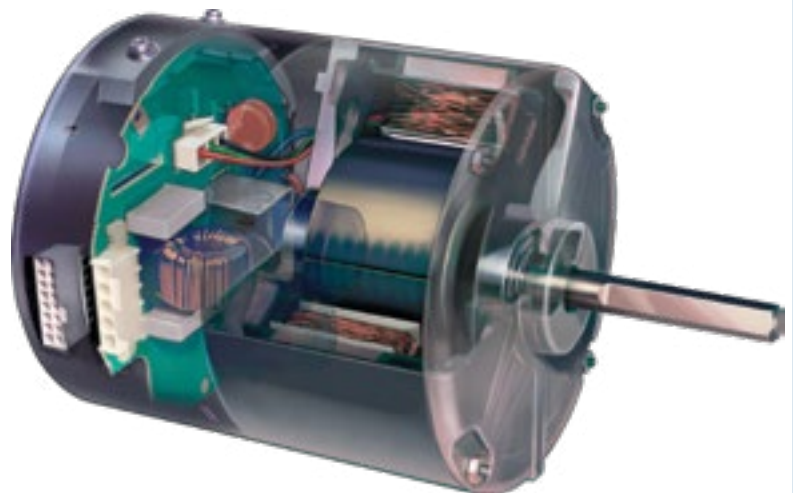

Your Safety is Our Number One Priority

NuAire's commitment to safety doesn't stop at meeting industry standards. NuAire continually performs dynamic tests to push the limits of our product's performance to ensure you and your laboratory personnel will remain safe.

Automatic Airflow Compensation - the Ultra High Efficiency motor will automatically increase or decrease speed to maintain proper airflow settings based on readings from FlowGard Electronic Control System.



True laminar (unidirectional) downward moving air flushes the work surface at 60 fpm (0.30 m/s) minimizing cross contamination.



A dynamic air barrier at the front of the cabinet separates the laboratory from the work zone environment at an air speed of 105 fpm (0.53 m/s).



The HEPEX™ Zero Leak Airflow system evenly disperses air over the supply and exhaust HEPA filters, minimizes vibration transfer, and eliminates potential leaks by surrounding positive pressure chambers with negative pressure.



Make it Easier on your Service Personnel

We at NuAire® have designed each LabGard® Biosafety Cabinet to be service friendly. **100%** of service functions can be performed at the front or top of the cabinet.

Drop Down Control Panel

A flip down control panel creates a workable tray for service technicians.

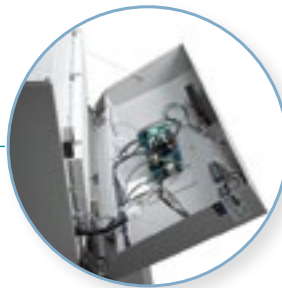

Exhaust Choke

Easy access to exhaust choke to certify airflows.



Front Filter Access

Access filters and the motor blower from the front of the cabinet with the removal of a safety panel.



DECON101 System

Easily connect to a variety of decontamination systems that use Formaldehyde, Chlorine Dioxide or Vapor Phase Hydrogen Peroxide

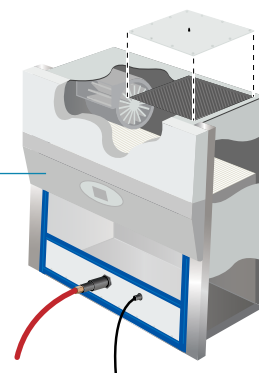

Controlled Safety - **FLOWGARD** Electronic Control System

The LabGard® AIR offers the latest digital microprocessor design technology for improved cabinet performance and safety. The FlowGard™ control system integrates a dual thermistor airflow sensor (*intelliflow*™) to monitor the cabinet's airflow performance. The FlowGard™ control system also integrates an ultra high efficiency motor / blower that provides automatic compensation for both filter loading and line voltage variances. The FlowGard™ also controls the motor / blower, visible light, UV light (optional), outlet(s), alarms, and the sliding window position via micro switches.



Dual Thermistor intelliflow Airflow Probe

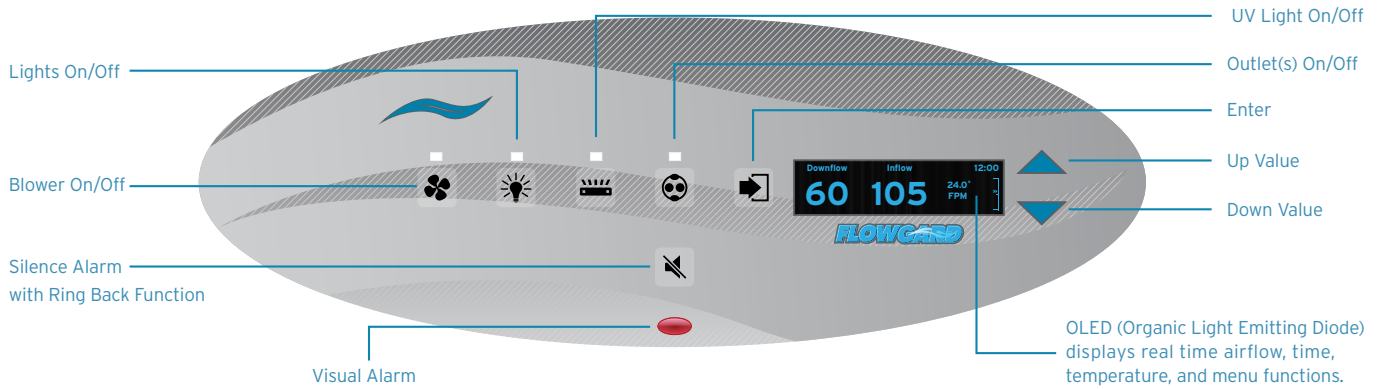

nitecare

Night Setback Mode - Upon sliding the window sash into the closed position, the motor blower will continue to operate at a lower rate to save energy and maintain interior clean air conditions ready for use upon window sash opening.

Perfectly Designed for You and Your Safety

Airflow Protects Personnel and Product

LabGard® AIR utilizes a single motor blower system to maintain airflow performance. The single motor blower system is inherently balanced. As particulates load the HEPA filters between certifications, NuAire's single motor/blower system maintains a consistent ratio of down flow to inflow, preventing uneven filter loading. This maintains a safer environment for you and your laboratory as well as maintains the proper down flow to minimize cross contamination within the work zone.

-  **HEPA Filtered Air**
-  **Contaminated Worksurface Air**
-  **Contaminated Room Air**
-  **Air Split**

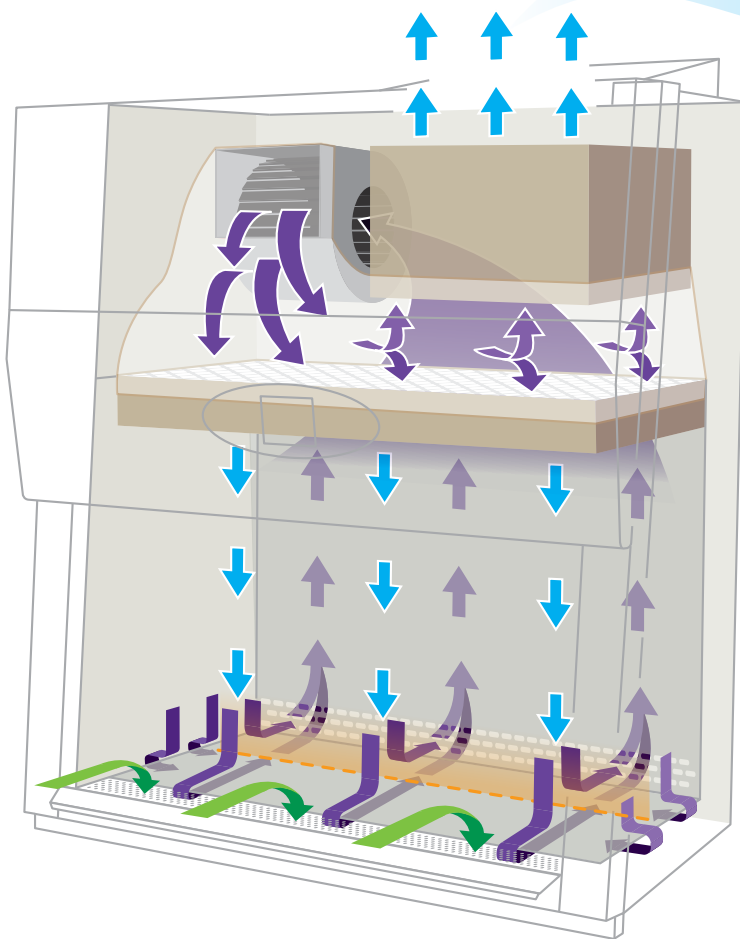

The LabGard NU-543 AIR is a Class II Type A2 Biological Safety Cabinet that can be either exhausted back into the room or connected to a facility HVAC system. The cabinet's airflow is 30% exhausted / 70% recirculated to minimize cross-contamination of sterile hazardous drugs and low to moderate risk biologicals in the absence of volatile toxic chemicals.

Specifications

Model	Width Size (nominal)	Electrical (all sizes)	Interior Dimensions (W x D x H) in [mm]	Exterior Dimensions (W x D x H) in [mm]	Net Weight
NU-543-300	3 ft [0.9 m]	115V 60Hz E/S: 230V 50/60Hz K: 115V 60HZ J: 100V 50/60Hz	34 ³ / ₈ x 25 ³ / ₄ x 28 ¹ / ₂ [873 x 654 x 724]	41 ⁵ / ₈ x 31 ⁷ / ₁₆ x 60 ⁷ / ₈ [1057 x 799 x 1546]	410 lbs [186 kg]
NU-543-400	4 ft [1.2 m]		46 ³ / ₈ x 25 ³ / ₄ x 28 ¹ / ₂ [1178 x 654 x 724]	53 ⁵ / ₈ x 31 ⁷ / ₁₆ x 60 ⁷ / ₈ [1362 x 799 x 1546]	480 lbs [218 kg]
NU-543-500	5 ft [1.5 m]		58 ³ / ₈ x 25 ³ / ₄ x 28 ¹ / ₂ [1483 x 654 x 724]	65 ⁵ / ₈ x 31 ⁷ / ₁₆ x 60 ⁷ / ₈ [1669 x 799 x 1546]	570 lbs [258 kg]
NU-543-600	6 ft [1.8 m]		70 ³ / ₈ x 25 ³ / ₄ x 28 ¹ / ₂ [1788 x 654 x 724]	77 ⁵ / ₈ x 31 ⁷ / ₁₆ x 60 ⁷ / ₈ [1972 x 799 x 1546]	640 lbs [290 kg]

* Specify models with appropriate letter suffix for electrical specifications. "NU-543-400E" for 230 VAC 50/60 Hz

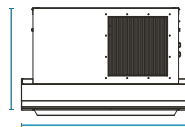
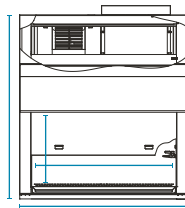
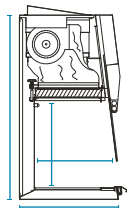

Features

Performance

Airflow 30% exhausted / 70% recirculated
 Dynamic Air Barrier 105 fpm (0.53 m/s) Inflow
 True Laminar Airflow 60 fpm (0.30 m/s) Down Flow
 Filter Load Capacity 300% Plus
 Filter Life ±10 Years
 NSF/ANSI 49, EN12469

Protection

HEPEX Zero Leak Airflow System
 ANSI/ASHRAE 110, Surrogate Powder, Biological Tested and Validated
 Airflow / Window Alarms with Ring Back Function
 Security Password Protection
 UL Listed, CE

Efficiency

Ultra High Efficiency ECM Eon™ Motor with Precision Engineered
 Forward Curved Fan
 Auto Filter Loading Compensation

Motor Speed Controller
 Internal Exhaust Damper
 nitecare Night Setback

Construction

Monolithic 16/18 Gauge, Type 304 Stainless Steel
 Welded Pressure Tight Construction (Silicone Free)
 Coved Interior Corners
 Removable Control Center
 Removable Stainless Steel Coved Work Tray
 Recessed and Removable Front Intake Grill
 Stainless Steel Spill Trough with Drain Valve
 Vibration Reducing Work Surface Support System
 External Non-Glare 100 lm/ft² Fluorescent Lighting
 Frame-less Sliding Viewing Window
 Metal Diffuser Over Supply Filter
 Permanent Positive Pressure Plenum with Quick Release Supply
 Filter Removal

Easy transport design
 100% Front Service Friendly

Ergonomics

Comfort 10° sloped front window
 ADA Compliant
 Large User-friendly Work zone with coved corners (20-3/4 inch (527mm) depth)
 Low noise ±62 dba operation with Ambient Conditions of 53 dba
 Maximum visibility into work zone 23.75-inches (603 mm) viewing area
 Easy slide front window sash, 21-inches (533 mm) full open
 Centrally located control panel
 Attenument Vibration Control

Design Your Own

Nominal Width

3-foot (0.9 m)
 4-foot (1.2 m)
 5-foot (1.6 m)
 6-foot (1.8 m)

Prop-up Work Tray
 Australian Test Method

Sidewalls

Stainless Steel
 Glass

Type H - Israel
 Type I - Australia
 Type J - Switzerland
 Type K - Netherlands
 Type M - South Africa

Access Opening

12" [305 mm] Access Opening (NSF/ANSI 49)
 10" [254 mm] Access Opening (NSF/ANSI 49, EN12469)
 8" [203 mm] Access Opening (NSF/ANSI 49)

Service Valves/Couplings

Smooth Interior
 Left/Right Bottom
 Left/Right Middle
 Left/Right Top

Seismic Brackets

Side Mount
 Rear Mount
 Floor Mount

Supply Filter

HEPA Filter 99.99% efficient @ 0.3 μ (NSF/ANSI 49)
 HEPA H14 Filter 99.995% efficient @ 0.025 MPPS (EN12469)

Plumbing

Soft Copper Pipe 3/8"
 Black Pipe 3/8" (Gas Only)
 Rigid Copper 1/2"

Custom Solutions

Microscope Window
 Sinks with Hot/Cold or DI water Faucets
 Heated Work-surface
 Widths and/or Heights

Exhaust Filter

HEPA Filter 99.99% efficient @ 0.3 μ (NSF/ANSI 49)
 HEPA H14 Filter 99.995% efficient @ 0.025 MPPS (EN12469)
 Redundant (Qty 2) HEPA H14 Filter 99.995% efficient @ 0.025 MPPS (EN12469)

Decorative Side Panels

None
 No Plumbing
 Plumbing Out Top
 Plumbing Out Back
 Plumbing Out Bottom

Base Stands

Telescoping Base Stand with Leg Levers or Casters
 Automatic Adjustable Base Stand with Leg Levers or Casters
 Base Storage Telescoping Base Stand with Leg Levers or Casters
 Base Stand Shelf [8 or 12-inch width (203 or 305 mm)]
 Ergo-tron Workstation for Monitor and Keyboard

Power

Power Cord
 Junction Box

External Lighting

Fluorescent [90 - 120 fc (968 - 1291 lux)]
 LED [90 - 120 fc (968 - 1291 lux)]

Outlets (Quantity 2)

Duplex Outlet (NEMA 5-15) (3 Amp Max)
 GFI Duplex Outlet (NEMA 5-15) (3 Amp Max)
 GFI Duplex Outlet (NEMA 5-15) (5 Amp Max)
 Duplex Outlet (NEMA 5-15) (15 Amp Max)
 GFI Duplex Outlet (NEMA 5-15) (15 Amp Max)
 Duplex Outlet (NEMA 5-20) (20 Amp Max)
 GFI Duplex Outlet (NEMA 5-20) (20 Amp Max)
 Duplex Outlet (NEMA 6-15) (15 Amp Max)
 Type D - United Kingdom
 Type E - France
 Type F - Schuko
 Type G - United Kingdom

Exhausting

Variable Range Low Flow Canopy (VFC) with Monitor
 External Airflow Alarms
 Flex Duct Kits
 Butterfly Dampers
 Silicone Connection Sleeve Kit
 Round to Round Transition [8 to 10-inch (203 to 254 mm)]

Armrest (Ergonomic)

Heavy duty plastic
 Metal

Ergonomics

Adjustable Footrest
 Stainless Steel Turn Table [12-inch (305 mm) Diameter]
 Small Elbow Rest [3 x 5-inches (76 x 127 mm)]
 Large Elbow Rest [3 x 10-inches (76 x 254 mm)]
 Foam Armrest Pads

Options

Ultraviolet Light
 IV Bar with 3 Height Locations, 6 Hooks
 NSF Approved Cord Pass Through
 Stainless Steel Window Edge Protector

Design Your Very Own

Each laboratory or pharmacy is unique and every application can differ. Set your laboratory up for success by designing your own NuAire Biosafety Cabinet. It can be as simple as adding a service valve or as involved as customizing the height of the work zone. NuAire can do it all. Invest in a product that lasts and is designed for your needs.

Popular Configurations:

Configuration 1 - Hazardous Drug Compounding



Smooth Interior for clean-ability

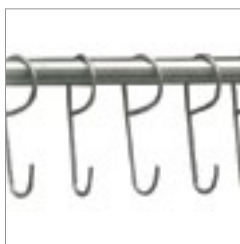

IV Bar with Three Locations and Six Hooks



Cord Pass-through (NSF Approved)



Stainless Steel Armrest



Prop Up Work Surface



VFC Exhaust Transition with Alarm



Silicone Sleeve Exhaust Connection Kit



Telescoping Base Stand with Ergotron Computer Monitor and Keyboard Arm and Base Stand Shelf

Configuration 2 - Tissue Culture



Service Valves/Couplings [Gas, Air, Vac]



Ultraviolet (UV) Light



Cord Pass-through (NSF Approved)



Prop Up Work Surface



Motorized Base Stand - Leg Levelers or Casters

Base Stands



Telescoping Base Stand
- Leg Levelers or Casters



Motorized Base Stand
- Leg Levelers or Casters



Storage Telescoping Base Stand
- Leg Levelers or Casters



Base Stand Shelf
- 8 or 12-inch width (203 or 305 mm)



Ergotron® Arm for Monitor and Keyboard / Mouse

Exhausting



VFC Exhaust Transition



Fixed Exhaust Canopy Transition w/ Alarm



Silicone Sleeve



Flex Duct



Manual and Automatic Butterfly Valves

Ergonomics



Stainless Steel Turntable
- [12-inch (305 mm) Diameter]



Elbow Rest
- Small Elbow Rest [3 x 5-inches (76 x 127 mm)]
- Large Elbow Rest [3 x 10-inches (76 x 254 mm)]



Adjustable Foot Rest

Built-in Options



LED Lighting (Replaces Fluorescent Lighting)

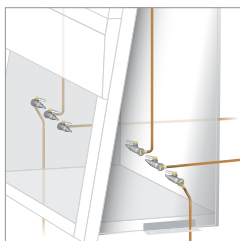

Pre-Piped Plumbing



Outlets



Cord Pass-through (NSF Approved)



Ultraviolet (UV) Light

Complete your Laboratory

NuAire offers a variety of Laboratory Equipment to meet the needs of the research, vivarium, pharmacy, environmental laboratory and more. Join the NuAire family and complete your laboratory with complementary NuAire Quality products.



LABGARD
Biosafety Cabinets



IN-VITROCELL^{ES}
CO₂ Incubators



NUVIND
Centrifuges



Koki
CENTRIFUGES



BLIZZARD
Ultralow Freezers



AIRECARD^{ES}
Laminar Airflow Workstations



PHARMAGARD^{ES}
Compounding Isolators



ALLERGARD^{ES}
Animal Laboratory Products



**Polypropylene Fume Hoods
and Casework**



Custom Solutions

Delivering product to the customer that is cost effective, exceeds their requirements, delivers product on-time, and increases productivity and profitability.

In every NuAire product you'll find brilliant but practical design, keen attention to detail in every phase of the fabrication and assembly process, thoroughly tested, outstanding value, and dependable service. These are the foundation for NuAire's international reputation, and practical reasons why NuAire is universally recognized as the finest. NuAire's Quality Policy to Satisfy Customers, Comply with Quality System Requirements and Continually Improve.

Sales and Service Like No Other NuAire employs a network of knowledgeable sales and service individuals some of which have been selling and servicing NuAire Laboratory Products since our inception in 1971.

Working Safely Video Series. Learn how to work safely in your NuAire Biological Safety Cabinet with this 7 Chapter online video series.



Our Sales Representatives are located throughout the globe providing you with a local individual who can assist product selection, pricing, installation, training, and service throughout the life of your product. Once you buy a NuAire you're a part of our family and we'll work hard to satisfy your needs.

NuAire offers service-training classes and individualize assistance to service professionals in the laboratory community. These NuAire certified companies are located throughout the world allowing NuAire to provide service and assistance to the farthest corners of the earth. Have the option to select from multiple service vendors in your area to find a company that fits your needs.

Contracts, GPO's and many more! NuAire has a variety of Contracts set up through Group Purchasing Organizations, Government Associations, Health Systems, Universities and many more.

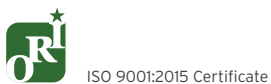

Your Local NuAire Partner



For more information please visit
www.nuaire.com or call **1.763.553.1270**

SHARE A PICTURE AND TAG YOUR NUAIRE BIOSAFETY CABINET USING #MYNUAIRE

